

DEBOURGH

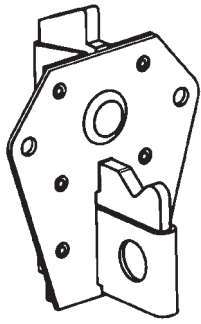

1. #D105
\$12.50 ea.

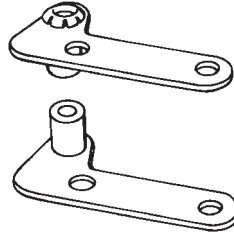

2. #D110
\$6.75 ea.

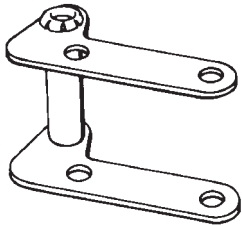

3. #D120
\$6.75 ea.

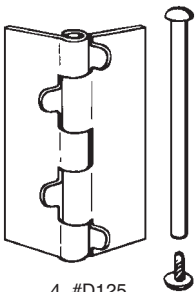

4. #D125
\$4.75 ea.

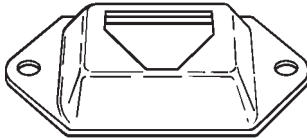

6. #D150
\$1.55 ea.



7. #D145
NEW STYLE
\$1.00 ea.



7. #D145
OLD STYLE

(New Style and Old Style are interchangeable)



8. #4120
\$0.15 ea.



11. #D140
\$1.30 ea.

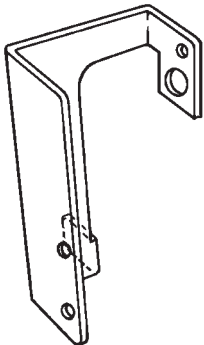

10. #D135
\$6.00 ea.

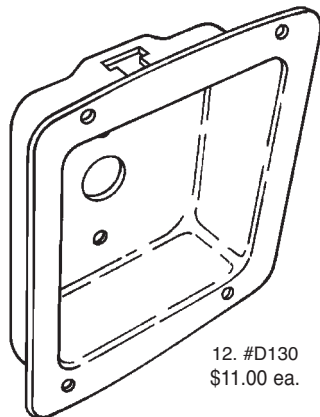

12. #D130
\$11.00 ea.

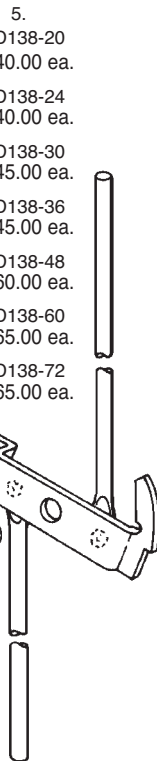

5.
A. #D138-20
\$40.00 ea.
B. #D138-24
\$40.00 ea.
C. #D138-30
\$45.00 ea.
D. #D138-36
\$45.00 ea.
E. #D138-48
\$60.00 ea.
F. #D138-60
\$65.00 ea.
G. #D138-72
\$65.00 ea.

1. GYM DOOR LATCH
Cat. No. D105
2. TOP/BOTTOM HINGE HOLDER
Cat. No. D110
3. CENTER HINGE HOLDER
Cat. No. D120
4. HINGE SET
Cat. No. D125

LOCKER DOOR HT.	PART NUMBER
A. 20"	D138-20
B. 24"	D138-24
C. 30"	D138-30
D. 36"	D138-36
E. 48"	D138-48
F. 60"	D138-60
G. 72"	D138-72

5. LOCK ROD WITH HANDLE
6. BOX LOCKER DOOR CATCH
Cat. No. D150
7. LOCKBAR RETAINING PLUG
Cat. No. D145
8. LATCH SPRING
Cat. No. 4120
9. NYLON LATCH
Cat. No. 4125
10. RECESSED HANDLE LIFT RH
Cat. No. D135
11. FINGER LIFT
Cat. No. D140
12. RECESSED HANDLE
Cat. No. D130

Additional Debourgh parts available, call for details.

Graffiti Remover
See page 39