

ALL-STEEL

All locker handles come with screws.

HANDLE BOLT—8-32 x 3/8



Cat. #1035
\$0.05



Cat. #5111
\$0.05



2 PIECE HANDLE
Cat. #5100
\$14.00



PADLOCK EYE
Cat. #5075
\$1.30
used with
5050 handle



1 PIECE HANDLE
Cat. #5050
1-23 = \$7.00
24-99 = \$6.50
100+ = \$6.00

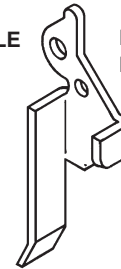

BOX LOCKER LATCH
Cat. #5212
1-99 = \$4.00
100+ = \$3.60



DOORSTOP
Cat. #5555
1-49 = \$2.35
50+ = \$2.25

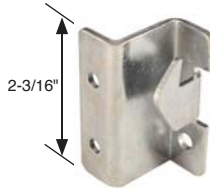

DOORSTOP
Cat. #5580
\$2.55



HINGE
Cat. #5300
\$5.10



CLIP
Cat. #5355
\$3.45

LATCH SPRING

Cat. #5400
\$3.25



CATCH
Cat. #5455
\$1.40



SPRING
Cat. #5665
\$0.75



STUD
Cat. #5635
\$0.85



BOX LOCKER LATCH (Old Style)
Cat. #5620
\$5.00



NOTE: All-Steel no longer manufactures lockers, therefore, we are unable to supply doors only, frames only or All-Steel door and frame assemblies. However, a door and frame assembly is available provided the installer make the necessary modifications. For more information, contact our office.

AURORA STEEL

LIFTER ONLY
Cat. #7360
\$4.45



RUBBER BUMPER
Cat. #7365
\$0.20

LIFTER PIN
Cat. #7475
\$1.05



LIFTER COVER
Cat. #7750
\$4.75

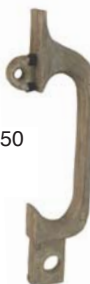

LOCKER HANDLE
Cat. #7111
\$9.00



FACE PLATE
Cat. #7811
\$3.95

LOCKING BAR ASSEMBLY

| ACTUAL LENGTH | LOCKER DOOR HT | CAT. NUMBER |
|---------------|----------------|-------------|
| 27" | 30" | 7030 |
| 32-15/16" | 36" | 7036 |
| 56-9/16" | 60" | 7060 |
| 68-3/8" | 72" | 7072 |

Cat. #7030
\$24.50

Cat. #7036
Not Available

Cat. #7060
\$32.50

Cat. #7072
Not Available



COMPLETE ASSEMBLY
Cat. #7000
\$6.15

LIFTER SPRING
Cat. #7540
\$0.55

LATCH
Cat. #7985
\$3.05



COIL SPRING
Cat. #7640
\$0.68



LATCH PIN
Cat. #7131
\$0.45



DOOR STOP
Cat. #7220
\$3.25



HINGE
Cat. #7615
\$3.75



NUMBER PLATE
Cat. #7850
\$1.30



RETAINING RIVET
Cat. #7416
\$0.45

WWW.CENTARIND.COM
e-mail:
CUSTSERVICE@CENTARIND.COM



Centar Industries INCORPORATED
16313 WESTWOODS BUSINESS PARK, ELLISVILLE, MO 63021
CALL TOLL FREE: 1-800-843-7878 • FAX 1-636-391-2336

IN ST. LOUIS CALL:
636-391-2333

ASI

FINGER LIFT (with rivet)
Cat. #AS105
\$1.75

RECESSED HANDLE LIFT
Cat. #AS110
\$4.95

RECESSED HANDLE FOR MULTIPOINT
Cat. #AS115
\$9.50

DOOR JAMB
Cat. #AS150
\$3.00

SP HASP FOR PADLOCK
Cat. #AS185
\$4.50

RECESSED HANDLE SINGLE POINT
Cat. #AS170
\$9.50

NYLON LATCH CLIP
Cat. #4125
1-99 = **\$0.40**
100-299 = **\$0.36**
300+ = **\$0.32**

NYLON LATCH CLIP SPRING
Cat. #4120
\$0.15

LATCH CHANNEL

| Cat. No. | Length | Price |
|----------|----------|----------------|
| AS30 | 20-7/8" | \$19.50 |
| AS36 | 27" | \$19.50 |
| AS6072 | 50-7/16" | \$19.50 |

Same latch channel used for 60" and 72" ST

Check out www.centarind.com for additional discounts and monthly specials through out the year!

GSS

PADLOCK HASP
Cat. #GSS20
\$7.00

RECESSED POCKET FOR PADLOCK
Cat. #GSS05
\$9.75

RECESSED POCKET BUILT-IN LOCK
Cat. #GSS10
\$9.75

PLASTIC HANDLE PULL NEW STYLE
Cat. #GSS15
\$4.25

OLD STYLE HANDLE PULL (Discontinued - Use GSS15)

LUG PLATE ASSEMBLY
Cat. #GSS25
\$4.95

Doors & frames Available. Please call our office.

WWW.CENTARIND.COM
e-mail:
CUSTSERVICE@CENTARIND.COM



Centar Industries INCORPORATED
16313 WESTWOODS BUSINESS PARK, ELLISVILLE, MO 63021
CALL TOLL FREE: 1-800-843-7878 • FAX 1-636-391-2336

IN ST. LOUIS CALL:
636-391-2333

DEBOURGH



GYM DOOR LATCH
Cat. #D105
\$12.50

CENTER HINGE HOLDER
Cat. #D120
\$6.75



TOP/BOTTOM HINGE HOLDER
Cat. #D110
\$6.75



LOCK ROD WITH HANDLE

| LOCKER DOOR HT. | CATALOG NUMBER |
|-----------------|----------------|
| 20" | D138-20 |
| 24" | D138-24 |
| 30" | D138-30 |
| 36" | D138-36 |
| 48" | D138-48 |
| 60" | D138-60 |
| 72" | D138-72 |

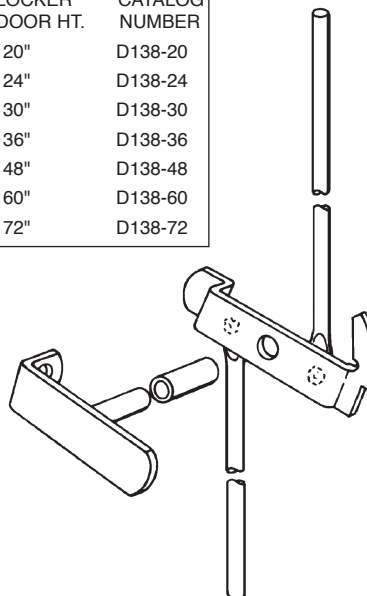

- Cat. #D138-20
\$40.00
- Cat. #D138-24
\$40.00
- Cat. #D138-30
\$45.00
- Cat. #D138-36
\$45.00
- Cat. #D138-48
\$60.00
- Cat. #D138-60
\$65.00
- Cat. #D138-72
\$65.00

BOX LOCKER DOOR CATCH

Cat. #D150
\$1.55



HINGE SET
Cat. #D125
\$4.75



LOCKBAR RETAINING PLUG



Cat. #D145
NEW STYLE
\$1.00



OLD STYLE

(New Style and Old Style are interchangeable)

LATCH SPRING
Cat. #4120
\$0.15



RECESSED HANDLE LIFT RH
Cat. #D135
\$6.00



FINGER LIFT
Cat. #D140
\$1.30



RECESSED HANDLE
Cat. #D130
\$11.00



NYLON LATCH
Cat. #4125
1-99 = **\$0.40**
100-299 = **\$0.36**
300+ = **\$0.32**

Graffiti Remover
See page 40



INTERIOR STEEL

All locker handles come with screws.

LOCK BAR ASSEMBLY Series 65 (After 1964)

- Cat. #3160
\$18.25
- Cat. #3172
\$19.50
- Cat. #3260
\$15.75
- Cat. #3272
\$17.00
- Cat. #3372
\$15.00

| CATALOG NUMBER | LOCKER TYPE | OVERALL LOCKER HEIGHT | LOCK BAR LENGTH |
|----------------|-------------|-----------------------|-----------------|
| 3160 | ST | 60" | 55-9/16" |
| 3172 | ST | 72" | 67-9/16" |
| 3260 | DT | 60" | 26-11/16" |
| 3272 | DT | 72" | 32-11/16" |
| 3372 | 3-T | 72" | 20-9/16" |



Replace with

LOCK BAR SCREW
Cat. #3145
\$0.05



LOCK BAR ASSEMBLY

Complete with Latch and Bars

- Cat. #3851
\$21.75
- Cat. #3852
\$21.75
- Cat. #3849
\$21.75
- Cat. #3850
\$22.95

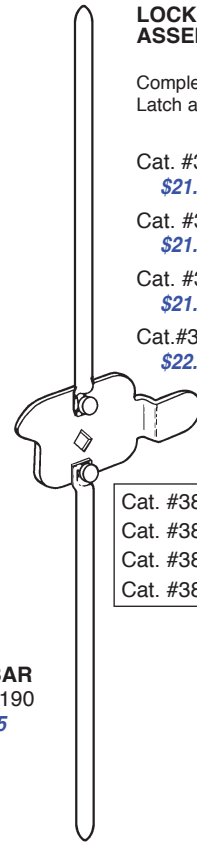

- Cat. #3851 30" DT
- Cat. #3852 36" DT
- Cat. #3849 60" ST
- Cat. #3850 72" ST



LOCK BAR
Cat. #3190
\$6.05

HANDLE LIFT
Cat. #3710
\$7.50

#3715 LH
Discontinued



STAINLESS STEEL RECESS HANDLE
Cat. #3725
\$12.75

HANDLE SCREWS



8-32 x 3/8
Cat. #1035
\$0.05

10-24 x 3/8
Cat. #1020
\$0.05

RETAINING CLIP
Cat. #3328



RECESSED HANDLE LIFTER
Cat. #3321
Cat. #3322



Replacements
#3725 & #3710

RECESSED HANDLE
Cat. #3325

1978 to
JAN. 1, 1989

HANDLE
Cat. #3829
\$9.25



HASP
Cat. #3675
\$1.85



HANDLE
Cat. #3264
1-49 = **\$7.30**
50-99 = **\$7.00**
100+ = **\$6.40**



LATCH LIFTER
Cat. #3370
\$1.45



Cat. #3320

INTERIOR CONTINUED ON NEXT PAGE

WWW.CENTARIND.COM
e-mail:
CUSTSERVICE@CENTARIND.COM



Centar Industries INCORPORATED
16313 WESTWOODS BUSINESS PARK, ELLISVILLE, MO 63021
CALL TOLL FREE: 1-800-843-7878 • FAX 1-636-391-2336

IN ST. LOUIS CALL:
636-391-2333

INTERIOR STEEL

All locker handles come with screws.



HANDLE
Cat. #3910
\$11.50



DISCONTINUED
HANDLE
Cat. #3925



KEEPER
Cat. #3100
\$8.25



HANDLE
Cat. #3099
\$23.65

COMPLETE ASSEMBLY
3 pieces
Cat. #3240
\$2.65



LATCH SPRING
Cat. #3246
1-99 = \$0.50
100+ = \$0.45



PLASTIC HOUSING
Cat. #3242
\$1.50



NYLON LATCH
Cat. #3244
1-99 = \$0.80
100-249 = \$0.70
250+ = \$0.65

METAL LATCH
Cat. #3250
\$0.95



SPRING
Cat. #3940
\$0.60

LATCH FINGER
Cat. #3945
\$1.20



DISCONTINUED
Cat. #3550
#3560

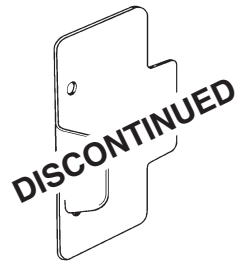

DISCONTINUED
Cat. #3540
Use #6719



LOCK BAR HOOK
Cat. #3057 LH
Cat. #3058 RH
\$2.60
(R.H. Shown)



LOCK BAR HOOK
Cat. #3501 RH
Cat. #3491 LH
\$2.75
(R.H. Shown)



LOCK COVER PLATE ASSEMBLY
Cat. #3580
\$2.90

SPRING ACTUATED LATCH

Cat. #3095
\$4.25

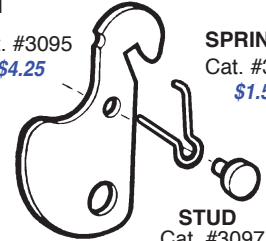

SPRING
Cat. #3096
\$1.55

STUD
Cat. #3097
\$1.60



HINGE
Cat. #3610
\$4.00



DOOR SPRING
Cat. #3410
\$1.50



NYLON ROLLER
Cat. #3460
\$0.80



DOOR BUMPER
Cat. #3440
\$0.25



(used on older Interior Steel Lockers)

TORQ-TITE WRENCH
Cat. #9025
\$19.95

Interior Steel is no longer in business, therefore, we are unable to supply doors and/or door and frame assemblies. However, a door and frame assembly is available provided the installer make the necessary modifications. For more information contact our office.

WWW.CENTARIND.COM
e-mail:
CUSTSERVICE@CENTARIND.COM



Centar Industries INCORPORATED
16313 WESTWOODS BUSINESS PARK, ELLISVILLE, MO 63021
CALL TOLL FREE: 1-800-843-7878 • FAX 1-636-391-2336

IN ST. LOUIS CALL:
636-391-2333

LYON

All locker handles come with screws.



HANDLE LIFT
Cat. #6782 RH
Cat. #6783 LH
1-11 = **\$3.00**
12-49 = **\$2.85**
50-99 = **\$2.60**
100+ = **\$2.45**

(RH Shown) 1981-current

STATIONARY HANDLE HOUSING
Cat. #6781
1-11 = **\$3.20**
12-49 = **\$3.10**
50-99 = **\$2.90**
100+ = **\$2.80**



HANDLE LIFT
Cat. #6742 RH
Cat. #6756 LH
1-11 = **\$2.90**
12-49 = **\$2.75**
50-99 = **\$2.65**
100+ = **\$2.30**

(RH Shown) Before 1981

STATIONARY HANDLE HOUSING
Cat. #6741
1-11 = **\$3.05**
12-49 = **\$2.85**
50-99 = **\$2.65**
100+ = **\$2.50**



HANDLE LIFT
Cat. #6739 RH
\$2.90
Cat. #6769 LH
\$3.20

(R.H. Shown)



LOCKER HANDLE
Cat. #6738
\$6.10

HANDLE RUBBER BUMPERS

DISCONTINUED
Cat. #6220
Handle 6738

Cat. #6225
\$0.15
Handle 6741

Cat. #6230
\$0.15
Handle 6741



HANDLE LIFT
Cat. #6649 RH
\$5.00
Cat. #6650 LH
\$5.25

(R.H. Shown)



FINGER LIFT
Cat. #6651
(9/2004-present) **\$1.30**
Cat. #6750
(Prior to 9/2004) **\$1.75**

HANDLE BOLTS

Cat. #6550
\$0.05
8-32 x 1/2"

Cat. #6555
\$0.05
8-32 x 1/4"

Cat. #6560
\$0.05
10 x 1/2"

Cat. #6565
\$0.05
6-32 x 1/4"

SCREW
Cat. #6205
\$0.30



Cat. #2085
\$0.05
8-32 x 5/16" long



WASHER
Cat. #6210
\$0.40



HANDLE HOUSING
Cat. #6748
\$15.25



HANDLE GUIDE & LIFT
Cat. #6745
\$18.90



LOCKER HANDLE
Cat. #6425
\$14.85

LIMITED SUPPLY AVAILABLE



HANDLE LIFT
(R.H. Shown)
Cat. #6135 RH
\$11.25
Cat. #6136 LH
\$11.25



RECESSED HOUSING
Cat. #6140
\$11.65



SINGLE POINT PADLOCK HASP
Cat. #6825
\$10.65



SINGLE POINT PADLOCK CUP
Cat. #6826
\$15.75



LOCKER HANDLE
Cat. #6459
\$16.95

HASP NOT AVAILABLE

LIMITED SUPPLY AVAILABLE

LYON CONTINUED ON NEXT PAGE

LYON



EXPANDED METAL LOCKER HANDLE

Cat. #6764
1-49 = **\$8.75**
50+ = **\$8.35**



LOCKER CAM ASSEMBLY

Cat. #6766 - 30" **\$19.00**
Cat. #6767 - 36" **\$19.00**
Cat. #6768 - 60" **\$20.00**
Cat. #6770 - 72" **\$21.00**



HINGE
Cat. #6709 **\$1.75**

HINGE BOLT
Cat. #6235 **\$0.10**



HINGE NUT
Cat. #9595 **\$5.00 per 100**

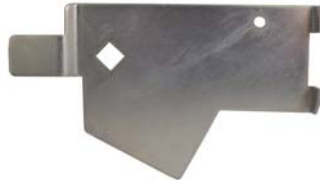

ADA CAM & WASHER
Cat. #6175 **\$12.50**



RUBBER BUMPER
Cat. #6785 **\$0.14**



WIRE BASKET PADLOCK ATTACHMENT
Cat. #6605 **\$1.65**



GRAVITY LATCH
Cat. #6758 **\$18.70**

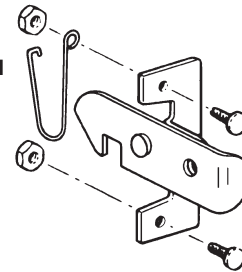

SPRING ACTUATED LATCH
Cat. #6757 **\$18.60**
SPRING ONLY
Cat. #6760 **\$1.90**



DOOR JAMB 2004 TO PRESENT
Cat. #6727 **\$3.20**



DOOR JAMB
Cat. #6726
1-23 = **\$3.15**
24-49 = **\$3.00**
50+ = **\$2.75**



DOOR JAMB
Cat. #6724 RH
Cat. #6725 LH
1-23 = **\$3.15**
24-49 = **\$3.00**
50+ = **\$2.75**
(R.H. Shown)



BOX LOCKER DOOR JAMB
Cat. #6763 **\$4.75**



DOOR JAMB
Cat. #6723
1-23 = **\$3.90**
24-49 = **\$3.70**
50+ = **\$3.45**



DOOR JAMB
Cat. #6749



BOX LOCKER DOOR PULL
Cat. #6719
1-499 = **\$1.45**
500+ = **\$1.35**

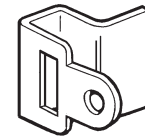

BOX LOCKER DOOR JAMB
Cat. #6728 **\$4.25**



2-PERSON DOOR JAMB
Cat. #6755 **\$5.25**



2-PERSON DOOR JAMB
Cat. #6754 **\$1.25**



ROLL POINT CATCH
Cat. #6753 **\$5.40**

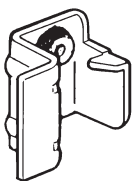

DOOR JAMB
Cat. #6721 **\$4.25**

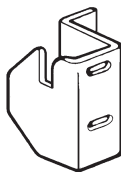

DOOR JAMB
Cat. #6627 **\$3.85**



DOOR JAMB
Cat. #6642

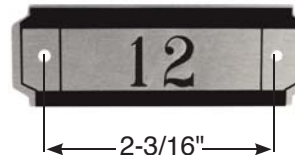

NUMBER PLATE
(Includes rivets)

Cat. #6829
1-249 = **\$0.80**
250-499 = **\$0.70**
500+ = **\$0.65**



EXTRA BLIND RIVET
Cat. #9567 **\$0.04**

WWW.CENTARIND.COM
e-mail:
CUSTSERVICE@CENTARIND.COM



Centar Industries INCORPORATED
16313 WESTWOODS BUSINESS PARK, ELLISVILLE, MO 63021
CALL TOLL FREE: 1-800-843-7878 • FAX 1-636-391-2336

IN ST. LOUIS CALL:
636-391-2333

LYON

LOCK BAR ASSEMBLY

Cat. #6794
\$26.25

Cat. #6795
\$18.60

Cat. #6798
\$15.25



(see page 23)

Cat. #6799
\$2.50

Cat. #6800
\$0.25

Sept. 2004 - Present
GALVANIZED

| ACTUAL LENGTH | LOCKER HEIGHT | CAT. NO. |
|---------------|---------------|----------|
| 53-1/4" | 60" or 72" | 6794 |
| 27-1/2" | 30" or 36" | 6795 |
| 41-7/8" | 48" | 6798 |

LOCK BAR ASSEMBLY

Cat. #6787
\$18.00

Cat. #6788 (Shown)
\$12.10

Cat. #6793
\$23.30



(see page 23)

LOCKING BAR SPRING
Cat. #6517
\$0.60

1981 - 9/2004
GALVANIZED

| ACTUAL LENGTH | LOCKER HEIGHT | CAT. NO. |
|---------------|---------------|----------|
| 56-1/2" | 60" or 72" | 6787 |
| 27-1/2" | 30" or 36" | 6788 |
| 44-1/2" | 48" | 6793 |

LOCK BAR ASSEMBLY

Cat. #6775
\$22.00

Cat. #6776 (Shown)
\$16.70



(see page 23)

LOCKING BAR SPRING
Cat. #6517
\$0.60

1980 - 1981
GALVANIZED

| ACTUAL LENGTH | LOCKER HEIGHT | CAT. NO. |
|---------------|---------------|----------|
| 56-1/2" | 60" or 72" | 6775 |
| 27-1/2" | 30" or 36" | 6776 |

LOCK BAR ASSEMBLY

Cat. #6735-1
\$22.50

Cat. #6735-2
\$24.00

Cat. #6736-1 (Shown)
\$17.75

Cat. #6736-2
\$18.75



(see page 23)

LOCKING BAR SPRING
Cat. #6520
\$0.65

1953 - 1980
PAINTED GRAY

| ACTUAL LENGTH | LOCKER HEIGHT | CAT. NO. |
|---------------|---------------|----------|
| 56-1/2" | 60" | 6735-1 |
| 68-1/2" | 72" | 6735-2 |
| 27-1/2" | 30" | 6736-1 |
| 33-1/2" | 36" | 6736-2 |

UPPER DOOR GUIDE
Cat. #6487
\$5.50



WIRE LATCH BAR FOR 2 PERSON-LONG, LH
1975 to Present
Cat. #6871
\$5.50



WIRE LATCH BAR FOR 2 PERSON-SHORT, RH
1975 to Present
Cat. #6870
\$5.50



LATCH BAR LONG, LH
Cat. #6817 (1970-75)
Cat. #6812 (1962-70)
\$19.75



LATCH BAR SHORT, RH
Cat. #6833 (1970-75)
Cat. #6893 (1962-70)
\$19.75



LOCK WIRE STRAP
Cat. #6773 RH
Cat. #6774 LH
\$0.85
(L.H. Shown)



BULLET CATCH
Cat. #6240
\$3.50



LOCKING BAR SPRING
Cat. #6505
\$3.50



LOCKING BAR SPRING ADJUSTMENT TOOL
Cat. #6530
\$15.50



2-PERSON UPPER DOOR - 15" WIDE
Cat. #6250 RH
Cat. #6255 LH
\$45.00

2-PERSON UPPER DOOR - 18" WIDE
Cat. #6260 RH
Cat. #6265 LH
Call for price



WWW.CENTARIND.COM
e-mail:
CUSTSERVICE@CENTARIND.COM



Centar Industries INCORPORATED
16313 WESTWOODS BUSINESS PARK, ELLISVILLE, MO 63021
CALL TOLL FREE: 1-800-843-7878 • FAX 1-636-391-2336

IN ST. LOUIS CALL:
636-391-2333

LIST / SUPERIOR / ART METAL / HALLOWELL

FINGER LIFT w/RIVET

Cat. #L105
\$1.50



RECESSED HANDLE HOUSING

Cat. #L220
\$15.50



RECESSED HANDLE

Cat. #L235
\$15.50



SINGLE POINT RECESSED CUP

Cat. #L200
\$17.50



HANDLE LIFT
Cat. #L110
\$6.95



RECESSED HANDLE
Cat. #L115
\$13.25

SINGLE POINT HASP ASSEMBLY Old style

Cat. #L205
\$11.95



SINGLE POINT HASP ASSEMBLY New style

Cat. #L207
\$15.25



Specify for welded or KD

HASP HOUSING

Cat. #L120
\$4.20



SPRING
Cat. #L125
\$0.75



LATCH
Cat. #L130
\$4.00



KEEPER
Cat. #L135
\$2.00



COMPLETE ASSEMBLY

Cat. #L119
\$10.50

(Includes L120, L125, L130 & L135)

LATCH HOOK Old style

Cat. #L145
\$2.40



LATCH HOOK New style

Cat. #L150
\$4.25



3-1/2" HINGE
Cat. #L140
\$3.00

2" HINGE For KD Locker
Cat. #L142
\$2.05

NEW STYLE DOOR JAMB

Cat. #L148
\$2.75
(new style)



BOX LOCKER DOOR JAMB

Cat. #L185
\$3.00



BOX LOCKER DOOR PULL

Cat. #L180
\$3.50



LATCH SPRING

Cat. #4120
\$0.15
(universal)



HINGE ROD (Prior to 6-86)

Cat. #L155
\$2.80



HINGE ROD (6-86 to Present)

Cat. #L160—11-1/4" long—\$7.75
Cat. #L161—14-1/4" long—\$9.25
Cat. #L162—17-1/4" long—\$10.90



LOCKER CHANNEL

| Cat. No. | Length | Price |
|-----------|----------|---------|
| L224-18KD | 16-3/4" | \$20.00 |
| L224-24KD | 20-3/4" | \$20.00 |
| L224-30KD | 26-7/16" | \$25.00 |
| L224-36KD | 32-7/16" | \$27.00 |
| L224-60KD | 55-1/2" | \$32.00 |
| L224-72KD | 67-7/16" | \$35.00 |
| L224-24W | 22-1/2" | \$20.00 |
| L224-30W | 28-1/2" | \$25.00 |
| L224-36W | 34-1/2" | \$28.00 |
| L224-60W | 58-1/2" | \$32.00 |
| L224-72W | 70-7/16" | \$42.00 |

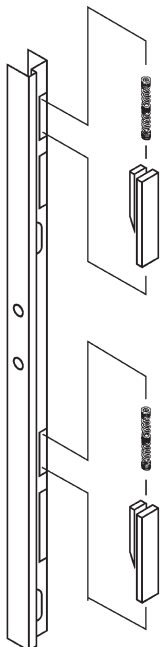

NYLON LATCH

OEM
Cat. #L170
\$0.80
OR
UNIVERSAL (White)
Cat. #4125
1-99 = \$0.40
100-299 = \$0.36
300+ = \$0.32



NYLON RIVET
Cat. #L175
\$0.25



SPL FRICTION BUTTON

Cat. #L190
\$0.25



FIELD ATTACHED SHELF STRIKE

Cat. #L195
\$1.25

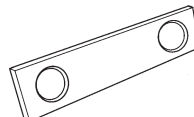

DOORS

Call for price
Specify width, height, color, and louvered or diamond mesh.

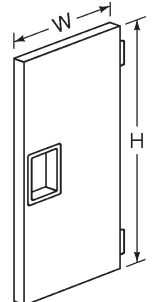

WWW.CENTARIND.COM
e-mail:
CUSTSERVICE@CENTARIND.COM



Centar Industries INCORPORATED
16313 WESTWOODS BUSINESS PARK, ELLISVILLE, MO 63021
CALL TOLL FREE: 1-800-843-7878 • FAX 1-636-391-2336

IN ST. LOUIS CALL:
636-391-2333

MEDART



DOOR STOP
Cat. #1117 RH
Cat. #1118 LH
\$1.75



DOOR STOP
Cat. #1121 RH
Cat. #1122 LH
\$2.00



DOOR STOP
Cat. #1125 RH
1-23 = **\$2.05**
24-99 = **\$1.95**
100+ = **\$1.85**

Cat. #1126 LH
\$2.05
(R.H. Shown)



DOOR STOP
Cat. #1160
\$2.45



DOOR STOP
Cat. #1129
1-23 = **\$2.05**
24-99 = **\$1.95**
100+ = **\$1.85**



DOOR STOP
Cat. #1765
\$3.50

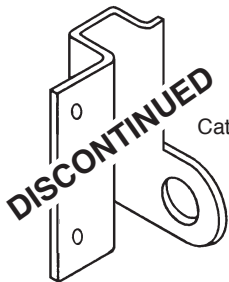

Cat. #1725

Used to mount door stops to locker frame.

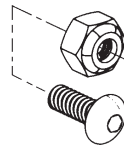

10-32 NYLON INSERT STOP NUT
Cat. #9640
\$0.10

10-32 X 1/2 CAP SCREW
Cat. #9645
\$0.15



SOLID RIVET
Cat. #1625
\$0.35



TUBULAR RIVET
Cat. #1570
\$0.10



2-PC RIVET
Cat. #1585
\$0.40



ROLLER
Cat. #1555
\$0.25

TUBULAR RIVET HAND TOOL

(used to set #1570 rivet)
Cat. #9090
\$25.50



LOCK ROD SPRING
Cat. #1250
1-99 = **\$0.45**
100-499 = **\$0.40**
500+ = **\$0.35**



LOCK ROD SPRING
Cat. #1500
1-99 = **\$0.45**
100-499 = **\$0.40**
500+ = **\$0.35**



PLASTIC LOCKROD SPRING
Cat. #1265 (1990-6/93)
\$0.60



NYLON SPRING AND RIVET
Cat. #1270 (Assembly) (6/93-5/94)
\$1.60
Cat. #1270A (Latch only - no spring or rivet)
\$1.10

Medart is no longer in business, therefore, we are unable to supply doors and/or door and frame assemblies. However, a door and frame assembly is available provided the installer make the necessary modifications. For more information contact our office.



LOCK ROD LATCH CLIP ASSEMBLY
Cat. #1300
\$2.75



DOOR STOP BUMPER
Cat. #1201
\$0.19



DOOR STOP BUMPER
Cat. #1205
\$0.19



PADLOCK HASP FOR WIRE
Cat. #1245
\$2.19

MEDART CONTINUED ON NEXT PAGE

WWW.CENTARIND.COM
e-mail:
CUSTSERVICE@CENTARIND.COM



Centar Industries INCORPORATED
16313 WESTWOODS BUSINESS PARK, ELLISVILLE, MO 63021
CALL TOLL FREE: 1-800-843-7878 • FAX 1-636-391-2336

IN ST. LOUIS CALL:
636-391-2333

MEDART

All locker handles come with screws.



FINGER LIFT
Cat #1945
\$1.50

RECESSED HANDLE
Cat. #1955
\$10.25



HANDLE LIFT
Cat. #1965 RH
Cat. #1966 LH
\$7.45
(R.H. Shown)



RECESSED HANDLE
Cat. #1956
\$12.50



SINGLE POINT HASP ASSEMBLY
Cat. #L205
\$11.95



SINGLE POINT RECESSED HANDLE
Cat. #3725SP
\$13.00
(Limited Supply)



HANDLE SCREW
Cat. #1020
\$0.05
10-24 x 3/8
For Handles #1005, #1007,
#1007 MD, #1109, #1111



HANDLE SCREW
Cat. #1035
\$0.05
8-32 x 3/8
For Handles #1001 RH,
#1001 LH, #1002 RH



BOX LOCKER PULL
Cat. #1060
\$2.10

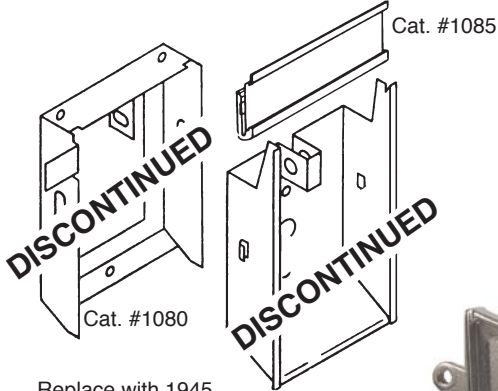

DISCONTINUED
Cat. #1080

DISCONTINUED
Cat. #1075

Replace with 1945,
1955, and 1965



LOCKER HANDLE
Cat. #1001 RH
Cat. #1001 LH
1-99 = **\$6.40**
100+ = **\$6.10**
(R.H. Shown)



HASP
Cat. #1150
For handle 1002RH
\$2.90

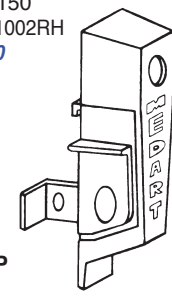

CONTROL ACCESS HANDLE
Cat #1002RH
\$16.00



PADLOCK HASP
Cat. #1215
\$0.95



PADLOCK HASP



LOCKER HANDLE
Cat. #1007 MD
\$12.00



LOCKER HANDLE
Cat. #1007
\$11.00



LOCKER HANDLE
Cat. #1005
1-24 = **\$5.65**
25-49 = **\$5.25**
50-99 = **\$4.90**
100+ = **\$4.60**

Cat. #1210 RH
Cat. #1211 LH
\$0.95



LOCKER HANDLE
Cat. #1109
1-99 = **\$7.75**
100+ = **\$7.50**



LOCKER HANDLE
Cat. #1111
1-99 = **\$7.90**
100+ = **\$7.75**



LOCKROD LIFT
Cat. #1230
\$1.50

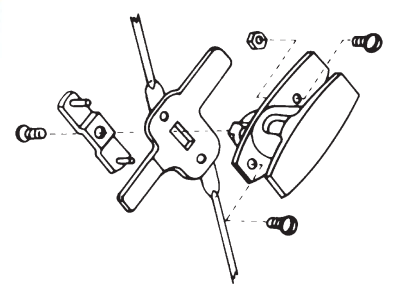

DISCONTINUED

WWW.CENTARIND.COM
e-mail:
CUSTSERVICE@CENTARIND.COM

Centar Industries INCORPORATED
16313 WESTWOODS BUSINESS PARK, ELLISVILLE, MO 63021
CALL TOLL FREE: 1-800-843-7878 • FAX 1-636-391-2336

IN ST. LOUIS CALL:
636-391-2333

MEDART

4-HOLE HINGE-1-1/2"



Cat. #1220
\$3.50

3-HOLE HINGE-2"



Cat. #1227
\$2.45



UPPER DOOR HINGE

Cat. #1785
\$3.50



LOCK BAR GUIDE

Cat. #1475
\$0.55



LOCK BAR RIVET

Cat. #1325
\$0.25



SHOULDER COLLAR

Cat. #1680
\$1.20

LOCKROD ASSEMBLY

| CAT. NO. | ACTUAL LENGTH |
|---------------------------------|---------------|
| #1412 \$11.55 | 8-7/8" |
| #1415 \$11.55 | 11-3/4" |
| #1418 \$13.00 | 14-3/4" |
| #1420 \$13.00 | 16-3/4" |
| #1424 \$14.50 | 20-3/4" |
| #1430 (Shown) \$15.25 | 26-1/2" |
| #1436 \$15.50 | 32-1/2" |
| #1452 \$20.75 | 43-1/2" |
| #1454 \$20.50 | 54-3/8" |
| #1460 \$17.85 | 49-1/2" |
| #1472 \$20.25 | 61-3/8" |

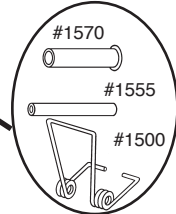

(see page 27)

LOCKROD ASSEMBLY

| CAT. NO. | ACTUAL LENGTH |
|------------------------------|---------------|
| #1424-3240 \$16.00 | 20-11/16" |
| #1430-3240 \$16.85 | 26-1/2" |
| #1436-3240 \$16.85 | 32-3/8" |
| #1460-3240 \$20.95 | 56-1/8" |
| #1472-3240 \$26.25 | 67-15/16" |

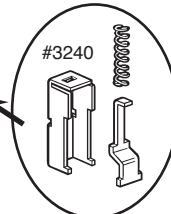

(see page 22)

TWO-PERSON LATCH BAR SHORT LH

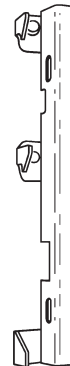

Cat. #1480
\$18.00

TWO-PERSON LATCH BAR SHORT RH

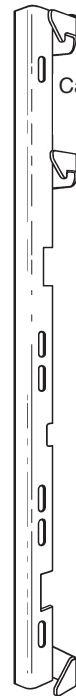

Cat. #1482
\$20.00

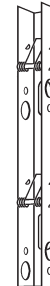

LOCKROD UPPER TWO-PERSON DOOR

Cat. #1485
\$10.00

TENNSCO/WILSON



HANDLE LIFT

Cat. #T105
\$4.00



FINGER LIFT

Cat. #T150
\$1.25



RECESSED HANDLE

Cat. #T110
\$6.00



ATTACHMENT RIVET

Cat. #T115
\$0.03



NYLON LOCK BAR RIVET

Cat. #T140
\$0.25



LATCH CLIP SPRING

Cat. #4120
\$0.15



NYLON LATCH CLIP

Cat. #4125
1-99 = **\$0.40**
100-299 = **\$0.36**
300+ = **\$0.32**



LOCKER HANDLE
Cat. #T120
\$15.95

DOOR JAMB
Cat. #T130
\$3.00



LATCH SPRING
Cat. #T125
\$0.80



STEEL LATCH
Cat. #T135
\$1.50

WWW.CENTARIND.COM
e-mail:
CUSTSERVICE@CENTARIND.COM



Centar Industries INCORPORATED
16313 WESTWOODS BUSINESS PARK, ELLISVILLE, MO 63021
CALL TOLL FREE: 1-800-843-7878 • FAX 1-636-391-2336

IN ST. LOUIS CALL:
636-391-2333

PENCO

All locker handles come with screws.

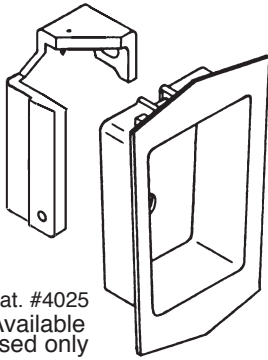

Cat. #4025
Available
used only

Cat. #4020
Available
used only

NOTE SPECIFY PALNUT

- #4380 Prior to 1972
- #4390 1972 to current



HANDLE HOUSING ONLY
Cat. #4010B
\$3.00



HANDLE SLIDE ONLY
Cat. #4010A
\$2.75



PADLOCK STAPLE
Cat. #4050
\$6.30

PALNUT Cat. #4385
\$0.20



LOCKER HANDLE
Cat. #4060
\$9.25

COMPLETE LOCKER HANDLE

- Cat. #4010
- 1-11 = \$5.00
- 12-24 = \$4.75
- 25-99 = \$4.50
- 100+ = \$4.25



PIN
Cat. #4705
\$0.12



DISCONTINUED
Cat. #4710



PLASTIC LIFT ONLY
Cat. #4725
\$1.75



RECESSED HANDLE
Cat. #4735
\$11.80



PLASTIC LIFT ONLY
Cat. #4725
\$1.75



SEAMLESS RECESSED HANDLE
Cat. #4750
\$11.80



LATCH
Cat. #4755
\$8.50



HOUSING
Cat. #4760
\$15.00

SINGLE POINT RECESSED HANDLE

HANDLE LIFT
Cat. #4730 RH
Cat. #4733 LH
\$7.15
(R.H. Shown)
Includes #4725

HANDLE LIFT
Cat. #4730 RH
Cat. #4733 LH
\$7.15
(R.H. Shown)
Includes #4725

- 8-32 X 1/2" DECORATIVE SCREW AND 8-32 NYLON INSERT STOP NUT
- Cat. #4740
- \$0.20



BUMPER DOOR STOP
Cat. #4155
\$0.20



DOORSTOP RIGHT HAND
Cat. #4195
\$1.75



DOORSTOP LEFT HAND
Cat. #4196
\$1.75



DISCONTINUED
PADLOCK HASP
Cat. #4075
\$2.50



DISCONTINUED
Cat. #4070



BOX LOCKER JAMB
Cat. #4315
\$2.30



WIRE BASKET PADLOCK ATTACHMENT
Cat. #4260
\$2.15



BOX LOCKER PULL
Cat. #4350
1-99 = \$3.70
100+ = \$3.40

WWW.CENTARIND.COM
e-mail:
CUSTSERVICE@CENTARIND.COM



Centar Industries INCORPORATED
16313 WESTWOODS BUSINESS PARK, ELLISVILLE, MO 63021
CALL TOLL FREE: 1-800-843-7878 • FAX 1-636-391-2336

IN ST. LOUIS CALL:
636-391-2333

PENCO

Check out www.centarind.com for additional discounts and monthly specials through out the year!



PALNUT TOOL
Cat. #4425
\$9.00



PALNUT
Cat. #4390
\$0.09



PALNUT TOOL
Cat. #4410
\$10.50



PALNUT
Cat. #4380
\$0.09



HINGE
Cat. #4220
\$1.25



REPLACEMENT CLIP GUIDE FOR LATCH BAR
Cat. #4670
\$2.00



NYLON LATCH CLIP SPRING
Cat. #4120
\$0.15



DISCONTINUED
Cat. #4625
(Use #4630)



SPRING
Cat. #4135
\$0.55



LOCK BAR

- Cat. #4530
\$14.90
- Cat. #4531
\$14.90
- Cat. #4536 (SHOWN)
\$17.20
- Cat. #4537
\$17.20
- Cat. #4532
Call for price
- Cat. #4533
Call for price
- Cat. #4544
\$18.00
- Cat. #4545
\$18.00
- Cat. #4560
\$25.50
- Cat. #4572
\$29.50



NYLON LATCH CLIP
Cat. #4125
1-99 = **\$0.40**
100-299 = **\$0.36**
300+ = **\$0.32**



RETAINING BUTTON
Cat. #4630
1-499 = **\$0.25**
500+ = **\$0.20**



STEEL LATCH CLIP
Cat. #4130
\$1.95



LOCK BAR FOR UPPER 2 PERSON
Cat. #4580 LH
Cat. #4583 RH
\$5.80



LATCH BAR (18-1/4" L)
Cat. #4511
\$19.25
LH



LATCH BAR (9-3/4" L)
Cat. #4519
\$14.30
RH

| ACTUAL LENGTH | DOOR HEIGHT | PART NO. |
|---------------|-------------|----------------------|
| 21-1/2" | 30" | 4530 (Prior to 2/96) |
| 21" | 30" | 4531 (After 2/96) |
| 27-1/2" | 36" | 4536 (Prior to 2/96) |
| 27" | 36" | 4537 (After 2/96) |
| 32-1/2" | 2 PR/RH | 4532 |
| 32-1/2" | 2 PR/LH | 4533 |
| 44-1/8" | 2 PR/LH | 4544 |
| 44-1/8" | 2PR/RH | 4545 |
| 50-5/8" | 60" | 4560 |
| 62-1/2" | 72" | 4572 |

WWW.CENTARIND.COM
e-mail:
CUSTSERVICE@CENTARIND.COM



Centar Industries INCORPORATED
16313 WESTWOODS BUSINESS PARK, ELLISVILLE, MO 63021
CALL TOLL FREE: 1-800-843-7878 • FAX 1-636-391-2336

IN ST. LOUIS CALL:
636-391-2333

REPUBLIC

All locker handles come with screws.

HANDLE LIFT ONLY

Cat. #2020A
\$2.50



HANDLE HOUSING ONLY

Cat. #2020B
\$2.50

HANDLE HOUSING ONLY

Cat. #2020B
\$2.50



HANDLE LIFT ONLY

Cat. #2030A
\$2.75



HANDLE LIFT ONLY

Cat. #2040A RH
\$3.50



HANDLE HOUSING ONLY

Cat. #2020B
\$2.50



LOCKER HANDLE - RH

Cat. #2020 RH
1-11 = \$3.50
12-99 = \$3.35
100+ = \$3.25
(complete handle)

LOCKER HANDLE - LH

Cat. #2030 LH
\$4.35
(complete handle)

LOCKER HANDLE

Cat. #2040 RH
1-11 = \$5.50
12+ = \$5.25
(complete handle)
Cat. #2045 LH
\$6.50
(left hand)



LOCKER HANDLE

Cat. #2070
1-11 = \$4.80
12-23 = \$4.50
24-99 = \$4.25
100+ = \$3.95



LOCKER HANDLE

Cat. #2050
1-11 = \$3.50
12+ = \$3.15



LOCKER HANDLE

Cat. #2060
1-11 = \$3.95
12+ = \$3.75



Cat. #2110
\$22.50



EXPANDED METAL LOCKER HANDLE

Cat. #2130
\$15.50

HANDLE BOLTS

8-32 X 5/16" Long
Cat. #2080
\$0.04



8-32 X 5/16" Long
Cat. #2085
\$0.05



8-32 X 1/2" Long
Cat. #2090
\$0.05



OLD STYLE DISCONTINUED
ESCUTCHEON PLATE BOX LOCKER
Cat. #2280
1-49 = \$1.45
50+ = \$1.40



BOX LOCKER FRICTION CATCH
Cat. #2290
\$2.75



PADLOCK HASP
Cat. #2055
\$1.60

Cat. #2180 Clip Only
\$5.40



PADLOCK HASP ASSEMBLY
Cat. #2147
\$10.25

(Specify padlock or built-in lock)



SINGLE POINT RECESSED HANDLE HOUSING
Cat. #2127
\$10.65



SLIDE
Cat. #2145 RH
Cat. #2146 LH
1-23 = \$4.95
24+ = \$4.60



FINGER LIFT
Cat. #2150
1-23 = \$1.30
24+ = \$1.20



RECESSED HANDLE HOUSING
Cat. #2125
1-23 = \$8.95
24+ = \$8.70

WWW.CENTARIND.COM
e-mail:
CUSTSERVICE@CENTARIND.COM



Centar Industries INCORPORATED
16313 WESTWOODS BUSINESS PARK, ELLISVILLE, MO 63021
CALL TOLL FREE: 1-800-843-7878 • FAX 1-636-391-2336

IN ST. LOUIS CALL:
636-391-2333

REPUBLIC

| | | |
|--|---|---|
| <p>HANDLE LATCH OLD STYLE</p> <p>SPRING Cat. #2565 \$0.65</p> <p>WASHER Cat. #2570 \$0.15</p> <p>HANDLE Cat. #2580 \$4.25</p> <p>STUD Cat. #2575 \$0.85</p> | <p>SPRING LATCH FOR HEAVY DUTY LOCKER NEW STYLE</p> <p>Cat. #2175 \$5.50</p> <p>Side View</p> | <p>DOOR STOP Cat. #2700 \$2.40</p> |
| <p>BRACKET Cat. #2555 Discontinued</p> <p>BUMPER Cat. #2560 \$0.80</p> | <p>WIRE BASKET PADLOCK ATTACHMENT Cat. #2709 \$1.75</p> | <p>HINGE Cat. #2706 \$2.00</p> |
| <p>DOOR STOP Cat. #2703 RH Cat. #2704 LH 1-11 = \$2.75 12+ = \$2.40 (R.H. Shown)</p> | <p>DOOR STOP Cat. #2715 \$1.85</p> | <p>LATCH FINGER SPRING Cat. #2775 1-99 = \$0.24 100-249 = \$0.20 250+ = \$0.18</p> |
| <p>NEW STYLE SPRING LATCH Cat. #2758 1-99 = \$0.26 100-249 = \$0.24 250+ = \$0.22</p> | <p>DISCONTINUED</p> <p>RETAINING BUTTON Cat. #4630 1-499 = \$0.25 500+ = \$0.20</p> | <p>LATCH FINGER BUMPER Cat. #2781 1-99 = \$0.30 100+ = \$0.25</p> <p>LATCH FINGER Cat. #2770 1-249 = \$0.60 250+ = \$0.57</p> |
| <p>WALL HOOK Cat. #2955 \$0.70</p> | <p>DOUBLE PRONG HOOK Cat. #2960 \$2.20</p> | <p>DOOR KNOB Cat. #2985 \$1.05 (screw included)</p> <p>DOUBLE DOOR BUMPER Cat. #2412 \$3.20</p> |
| <p>TOP CAM FOR DOUBLE DOOR LOCKER ASSEMBLY</p> <p>STUD Cat. #2417 \$3.20</p> <p>TOP SPRING Cat. #2413 \$3.00</p> <p>TOP CAM Cat. #2410 \$4.80</p> | <p>DOUBLE PRONG HOOK Cat. #2950 \$1.25</p> | <p>BOTTOM CAM FOR DOUBLE DOOR LOCKER ASSEMBLY</p> <p>STUD Cat. #2417 \$3.20</p> <p>BOTTOM SPRING Cat. #2408 \$3.00</p> <p>BOTTOM CAM Cat. #2405 \$4.80</p> |

REPUBLIC CONTINUED ON NEXT PAGE

WWW.CENTARIND.COM
e-mail:
CUSTSERVICE@CENTARIND.COM



Centar Industries INCORPORATED
16313 WESTWOODS BUSINESS PARK, ELLISVILLE, MO 63021
CALL TOLL FREE: 1-800-843-7878 • FAX 1-636-391-2336

IN ST. LOUIS CALL:
636-391-2333

REPUBLIC

LOCKRODS

(Current Style Only After 1972)

* Specify if Lock Bars are for upper or lower doors.

R Used with recessed handle 2125.

- Cat. #2818
\$16.50
- Cat. #2820
\$16.50
- Cat. #2824
\$18.90
- Cat. #2825
\$18.90
- Cat. #2830
\$16.20
- Cat. #2831 (SHOWN)
\$15.50
- Cat. #2832
\$17.50
- Cat. #2836
\$18.90
- Cat. #2837
\$17.90
- Cat. #2838
\$18.90
- Cat. #2860
\$23.75
- Cat. #2861
\$25.25
- Cat. #2872
\$29.00
- Cat. #2873
\$30.75
- Cat. #2840
\$25.25
- Cat. #2841
\$25.25
- Cat. #2846
\$31.00
- Cat. #2847
\$31.00

| PART NO | DOOR SIZE | ACTUAL SIZE | NUMBER OF TIERS | HANDLE |
|---------------|-----------|-------------|-----------------|--------|
| * 2818 | 18" H | 14-7/8" | 4 Tier 6' High | 2020 |
| * 2820 | 20" H | 16-11/32" | 3 Tier 5' High | 2020 |
| * 2824 | 24" H | 20-11/32" | 3 Tier 6' High | 2020 |
| R 2825 | 24" H | 18-11/16" | 3 Tier 6' High | 2125 |
| 2830 | 30" H | 26-3/16" | 2 Tier 5' High | 2020 |
| 2831 | 30" H | 18-3/8" | 2 Tier 5' High | 2020 |
| R 2832 | 30" H | 24-1/2" | 2 Tier 5' High | 2125 |
| 2836 | 36" H | 32-3/16" | 2 Tier 6' High | 2020 |
| 2837 | 36" H | 24-3/8" | 2 Tier 6' High | 2020 |
| R 2838 | 36" H | 30-1/2" | 2 Tier 6' High | 2125 |
| 2860 | 60" H | 47-29/32" | 1 Tier 5' High | 2020 |
| R 2861 | 60" H | 47-7/8" | 1 Tier 5' High | 2125 |
| 2872 | 72" H | 60" | 1 Tier 6' High | 2020 |
| R 2873 | 72" H | 60" | 1 Tier 6' High | 2125 |
| 2840 | RH | 28-7/8" | 2 Pr. 5' High | 2020 |
| 2841 | LH | 28-7/8" | 2 Pr. 5' High | 2020 |
| 2846 | RH | 40-7/8" | 2 Pr. 6' High | 2020 |
| 2847 | LH | 40-7/8" | 2 Pr. 6' High | 2020 |

EXPANDED METAL LOCK BAR ASSEMBLY

- Cat. #2630 - 30" DT
\$25.50
 - Cat. #2636 - 36" DT
\$25.50
 - Cat. #2660 - 60" ST
\$25.50
 - Cat. #2672 - 72" ST
\$25.50
- Cat. #2130
(see page 32)

TWO PERSON UPPER DOORS

Door can be used as an upper or lower. Hardware not included on old style doors.



TWO PERSON LATCH BAR -Short RH

Cat. #2611
\$24.00



TWO PERSON LATCH BAR -Long LH

Cat. #2616
\$27.00



OLD STYLE

- Cat. #2915—15" WIDE
\$27.50
- Cat. #2918—18" WIDE
\$27.50

NEW STYLE

- Cat. #2115—15" WIDE
\$36.75
- Cat. #2118—18" WIDE
\$41.25

SHOULDER RIVET

Cat. #2605
\$0.50



PLASTIC GLIDE FOR LOCK BAR WITH RECESSED HANDLE

Cat. #2620
\$1.10

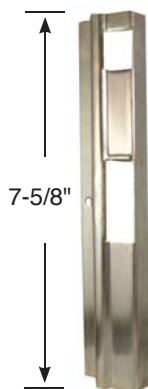

OLD STYLE RIGHT HAND LOCKING BAR FOR UPPER DOOR

Cat. #2791
\$7.80
Prior to 1972



OLD STYLE LEFT HAND LOCKING BAR FOR LOWER DOOR

Cat. #2790
\$7.80
Prior to 1972



NEW STYLE LOCKING BAR FOR UPPER DOOR

Cat. #2753
\$8.80

WWW.CENTARIND.COM
e-mail:
CUSTSERVICE@CENTARIND.COM



Centar Industries INCORPORATED
16313 WESTWOODS BUSINESS PARK, ELLISVILLE, MO 63021
CALL TOLL FREE: 1-800-843-7878 • FAX 1-636-391-2336

IN ST. LOUIS CALL:
636-391-2333

WORLEY

All locker handles come with screws



HANDLE BUMPER BOX
Cat. #8022
\$3.25

HANDLE RUBBER BUMPER ONLY (Upper/Lower)
Cat. #8026
\$0.09



ROLL PIN
Cat. #8037
\$0.10

HANDLE SLIDE
Cat. #8030
\$3.50



HANDLE CASE
Cat. #8045
\$5.00

EXTRA HANDLE BOLT 8-32 X 5/16"



Cat. #2085
\$0.05



HANDLE
Cat. #8005
\$18.50

EXTRA HANDLE BOLT 8-32 X 1/2"



Cat. #2090
\$0.05



METAL PLUNGER (shown)
Cat. #8054
\$0.60

NYLON PLUNGER
Cat. #8053
\$0.48



JAMB CLIP
Cat. #8058
1-299 = **\$0.80**
300+ = **\$0.70**

PLUNGER SPRING
Cat. #8056
1-99 = **\$0.16**
100-299 = **\$0.11**
300+ = **\$0.09**



BASKET HANDLE
Cat. #8315
\$3.00



LOCK PLATE
Cat. #8083
\$2.40



LOCK STOP
Cat. #8165
\$2.90



JAMB ONLY
Cat. #8055
\$3.10



Cat. #8067



HINGE
Cat. #8060
\$2.40



LOCK BAR

| PART No. | DOOR SIZE | ACTUAL SIZE | PRICE |
|-----------|-----------|-------------|----------------|
| Cat. 8418 | 18" | 13-39/64" | \$ 7.00 |
| Cat. 8420 | 20" | 15-37/64" | \$ 7.40 |
| Cat. 8424 | 24" | 19-35/64" | \$ 7.60 |
| Cat. 8427 | 27" | 22-1/2" | \$ 7.70 |
| Cat. 8430 | 30" | 25-29/64" | \$ 8.75 |
| Cat. 8436 | 36" | 31-23/64" | \$ 9.25 |
| Cat. 8442 | 42" | 37-17/64" | \$10.50 |
| Cat. 8448 | 48" | 43-11/64" | \$12.00 |
| Cat. 8454 | 54" | 49-5/64" | \$13.40 |
| Cat. 8460 | 60" | 54-63/64" | \$14.50 |
| Cat. 8472 | 72" | 66-51/64" | \$15.25 |

JAMB COMPLETE ASSEMBLY
Cat. #8050
\$4.50

TINNERMAN CLIP
Cat. #8063
\$0.35



SHOULDER RIVET
Cat. #8150
\$0.30



HANDLE LATCH
Cat. #8072
\$2.65



SHOULDER RIVET
Cat. #8180
\$0.30

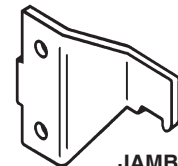

JAMB GRAVITY
Cat. #8077
\$1.40



DOOR STOP GRAVITY
Cat. #8075
\$1.35

WWW.CENTARIND.COM
e-mail:
CUSTSERVICE@CENTARIND.COM



Centar Industries INCORPORATED
16313 WESTWOODS BUSINESS PARK, ELLISVILLE, MO 63021
CALL TOLL FREE: 1-800-843-7878 • FAX 1-636-391-2336

IN ST. LOUIS CALL:
636-391-2333

MISCELLANEOUS

Hardware not included with #9005, #9010, and #9015. Use 9520 bolt and 9580 hex nut.



UNIVERSAL DOUBLE PRONG HOOK

Cat. #9005
\$0.70



UNIVERSAL SINGLE PRONG WALL HOOK

Cat. #9010
\$0.35



LOCK HOLE COVER PLATE

Cat. #9015
\$0.35



ALUMINUM NUMBER PLATE
(Fits all manufacturers except LYON)
Rivets 9563 included

Cat. #9020
1-499 = \$0.60
500+ = \$0.54
(#1-2000 in stock)



LEXAN PAINT PROTECTOR
Cat. #9105
\$1.50
4 Rivets included

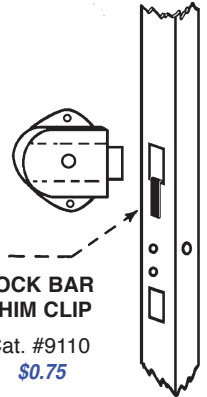

LOCK BAR SHIM CLIP
Cat. #9110
\$0.75



(used on older Interior Steel Lockers)

TORQ-TITE WRENCH
Cat. #9025
\$19.95



GULMITE HEAD WRENCH
Cat. #9030
\$25.50



WAX STICK
Cat. #9035
\$14.00



SILACONE SPRAY LUBE
Cat. #9040
\$5.00



LOCKER DOOR JAMB TOOL
Cat. #9450
\$16.75



TUBULAR RIVET HAND TOOL
Cat. #9090
\$25.50

Hardware not included with #9071 and #9073.
Use 9525 bolt and 9595 kep nut.

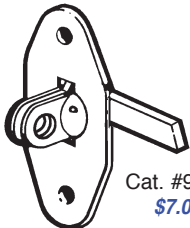

Cat. #9065
\$7.00



PADLOCK STAPLE
Cat. #9071
\$0.65



PADLOCK STAPLE
Cat. #9073
\$0.65



DOOR KNOB
Cat. #2985
\$1.05
(screw included)

WWW.CENTARIND.COM
e-mail:
CUSTSERVICE@CENTARIND.COM



Centar Industries INCORPORATED
16313 WESTWOODS BUSINESS PARK, ELLISVILLE, MO 63021
CALL TOLL FREE: 1-800-843-7878 • FAX 1-636-391-2336

IN ST. LOUIS CALL:
636-391-2333

MISCELLANEOUS

FASTENER ITEMS

(PACKAGED PER 100)

Check out www.centarind.com for additional discounts and monthly specials through out the year!



Cat. #9512
8-32 x 3/8 Bolt
Flat Hd. **Phillips**
\$5.00 per 100



Cat. #9575
8-32 Hex Nut
\$1.50 per 100



Cat. #9515
10-24 x 7/16 Bolt
Truss Hd. **Slotless**
\$4.00 per 100



Cat. #9545
1/4-20 x 5/8 Bolt
Truss Hd. **Slotted**
\$13.00 per 100



Cat. #9580
10-24 Hex Nut
\$1.50 per 100



Cat. #9520
10-24 x 3/8 Bolt
Truss Hd. **Slotless**
\$4.00 per 100



Cat. #9560
10 x 5/8 Round Hd.
Slotted Metal Screw
\$8.00 per 100



Cat. #9590
8-32 Kep Nut
\$5.00 per 100



Cat. #9525
10-24 x 1/2 Bolt
Truss Hd. **Slotless**
\$4.00 per 100



Cat. #9563
1/8 x 1/4" Blind Rivet
\$3.00 per 100
For Number Plates



Cat. #9595
10-24 Kep Nut
\$5.00 per 100



Cat. #9605
1/4 Kep Nut
\$6.00 per 100



DISCONTINUED

Cat. #9530
10-24 x 5/8 Bolt
Truss Hd. **Slotless**



Cat. #9662
3/16 x 1/2" Multi-Grip Rivet
\$6.00 per 100



Cat. #9610
8 Star Washer
External
\$4.00 per 100



Cat. #9533
8-32 x 5/8 Bolt
Truss Hd. **Phillips**
\$4.00 per 100



Cat. #9663
3/16" x 5/8" Multi-Grip Rivet
\$7.00 per 100



Cat. #9615
8 Lock Washer
\$3.00 per 100



Cat. #9535
10-24 x 1/2 Bolt
Truss Hd. **Slotted**
\$4.00 per 100



Cat. #9620
3/16 Flat Washer
\$8.00 per 100

WWW.CENTARIND.COM
e-mail:
CUSTSERVICE@CENTARIND.COM



Centar Industries INCORPORATED
16313 WESTWOODS BUSINESS PARK, ELLISVILLE, MO 63021
CALL TOLL FREE: 1-800-843-7878 • FAX 1-636-391-2336

IN ST. LOUIS CALL:
636-391-2333