

CHAIR GLIDES

SAMPLE KIT

- Avoid confusion
- Eliminate errors
- 18 of the most popular glides included

Only **\$13.00**

"**FREE**" with your purchase of \$250.00 or more of chair glides.



Cat. No.
G-KIT

	UNIVERSAL GLIDE REMOVAL TOOL	
	CAT #	G-Tool
	\$19.75	

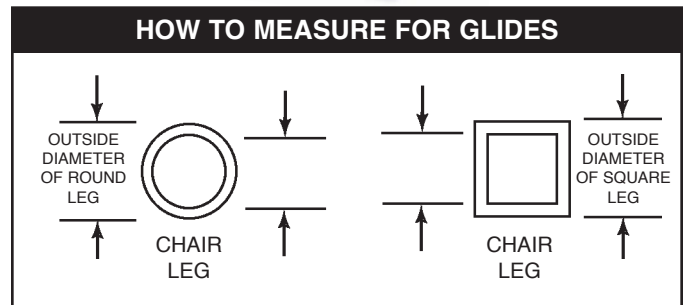

	ADJUSTABLE HEIGHT LEG	
	Cat # G-380	
	Holes punched at 1" increments	
	Height adjustable from 22" – 30"	
Includes mounting screws.		\$10.00

	IRWIN SEATING	
	For 1/2" O.D. Tubing Aluminum Cap Furnished to Secure Guide Cat # G-65	
	\$.85	

	PLASTIC PLUG	
	I.D.	CAT #
	3/4"	G-375
	1-9 = \$19.00 per 100	
	10-29 = \$17.00 per 100	
30+ = \$15.00 per 100		

Sold in 100's only.

	KRUEGER SWIVELGLIDE		
	BASE	I.D.	CAT #
	1-1/8"	5/8"	G-360
	Stem tilts in all directions.		
\$.95			

WWW.CENTARIND.COM
e-mail:
CUSTSERVICE@CENTARIND.COM

Centar Industries INCORPORATED
16313 WESTWOODS BUSINESS PARK, ELLISVILLE, MO 63021
CALL TOLL FREE: 1-800-843-7878 • FAX 1-636-391-2336

IN ST. LOUIS CALL:
636-391-2333

CHAIR GLIDES

SOLO GLIDE

- Swivels 32°
- A variety of bases available - nylon, rubber, felt, and steel
- Works on all floors
- Flexible glide bases can be changed to fit your changing needs
- Glide base changes in seconds
- Long lasting, attractive and quiet
- Fits on any chair
- Lifetime warranty (not including replaceable base)





	1-1/8 SOLO PLATFORM GLIDE FELT BASE			
	O.D.	CAT #	1-99	100+
	5/8"	G-4058F	\$.94	\$.84
	3/4"	G-4034F	\$.94	\$.84
	7/8"	G-4078F	\$.99	\$.90
	1"	G-4100F	\$1.05	\$.95
	1-1/8"	G-4125F	\$1.10	\$1.00
	1-1/4"	G-4250F	\$1.10	\$1.00

	FELT BASE REPLACEMENT	
	Cat # G-Felt	
1-99 = \$.40		
100 + = \$.36		

	1-1/8 SOLO PLATFORM GLIDE STEEL BASE			
	O.D.	CAT #	1-99	100+
	5/8"	G-4058S	\$.94	\$.84
	3/4"	G-4034S	\$.94	\$.84
	7/8"	G-4078S	\$.99	\$.90
	1"	G-4100S	\$1.05	\$.95
	1-1/8"	G-4125S	\$1.10	\$1.00
	1-1/4"	G-4250S	\$1.10	\$1.00

	STEEL BASE REPLACEMENT	
	Cat # G-Steel	
1-99 = \$.40		
100 + = \$.36		

	1-1/8 SOLO PLATFORM GLIDE NYLON BASE			
	O.D.	CAT #	1-99	100+
	5/8"	G-4058N	\$.75	\$.69
	3/4"	G-4034N	\$.75	\$.69
	7/8"	G-4078N	\$.80	\$.72
	1"	G-4100N	\$.82	\$.74
	1-1/8"	G-4125N	\$.88	\$.79
	1-1/4"	G-4250N	\$.88	\$.79

	NYLON BASE REPLACEMENT	
	Cat # G-Nylon	
1-99 = \$.25		
100 + = \$.23		

	1-1/8 SOLO PLATFORM GLIDE RUBBER BASE			
	O.D.	CAT #	1-99	100+
	5/8"	G-4058R	\$.94	\$.84
	3/4"	G-4034R	\$.94	\$.84
	7/8"	G-4078R	\$.99	\$.90
	1"	G-4100R	\$1.05	\$.95
	1-1/8"	G-4125R	\$1.10	\$1.00
	1-1/4"	G-4250R	\$1.10	\$1.00

	RUBBER BASE REPLACEMENT	
	Cat # G-Rubber	
1-99 = \$.40		
100 + = \$.36		

WWW.CENTARIND.COM
e-mail:
CUSTSERVICE@CENTARIND.COM



Centar Industries INCORPORATED
16313 WESTWOODS BUSINESS PARK, ELLISVILLE, MO 63021
CALL TOLL FREE: 1-800-843-7878 • FAX 1-636-391-2336

IN ST. LOUIS CALL:
636-391-2333

CHAIR GLIDES

STEEL BASE GLIDES



NYLON BASE GLIDES



VIRCO, ARTCO BELL, PEABODY, GRIGGS

BASE		O.D.	CAT #
1-1/4"	Steel	5/8"	G-55
1-1/4"	Nylon	5/8"	G-55N
1-99 = \$.50 100-199 = \$.45 200+ = \$.40			



SCHOLAR CRAFT, AMERICAN SEATING, COLUMBIA, GRIGGS

BASE		O.D.	CAT #
1-1/4"	Steel	5/8"	G-60
1-1/4"	Nylon	5/8"	G-60N
1-99 = \$.50 100-199 = \$.45 200+ = \$.40			



SCHOLAR CRAFT, AMERICAN SEATING, COLUMBIA, GRIGGS

BASE		O.D.	CAT #
1-1/4"	Steel	3/4"	G-95
1-1/4"	Nylon	3/4"	G-95N
1-99 = \$.65 100-199 = \$.60 200+ = \$.53			



HEYWOOD WAKEFIELD

BASE		O.D.	CAT #
1-1/4"	Steel	9/16"	G-20
1-1/4"	Nylon	9/16"	G-20N
1-199 = \$.65 200+ = \$.60			



AMERICAN DESK

BASE		O.D.	CAT #
1-1/4"	Steel	11/16"	G-100
1-1/4"	Nylon	11/16"	G-100N
1-199 = \$.70 200+ = \$.63			



COLUMBIA

BASE		O.D.	CAT #
1-1/4"	Steel	7/8"	G-50
1-1/4"	Nylon	7/8"	G-50N
1-99 = \$.79 100-199 = \$.71 200+ = \$.62			
BASE		O.D.	CAT #
1-1/4"	Steel	1-1/8"	G-32
1-1/4"	Nylon	1-1/8"	G-32N
1-199 = \$.69 200+ = \$.60			



COLUMBIA

BASE		O.D.	CAT #
1-1/4"	Steel	1"	G-30
1-1/4"	Nylon	1"	G-30N
1-99 = \$.70 100-199 = \$.64 200+ = \$.56			



HEYWOOD WAKEFIELD, AMERICAN DESK

BASE		O.D.	CAT #
1-1/4"	Steel	9/16"	G-37
1-1/4"	Nylon	9/16"	G-37N
1-1/4"	Steel	5/8"	G-35
1-1/4"	Nylon	5/8"	G-35N
1-99 = \$.63 100-199 = \$.54 200+ = \$.49			



HEYWOOD WAKEFIELD

BASE		O.D.	CAT #
1-1/4"	Steel	3/4"	G-40
1-1/4"	Nylon	3/4"	G-40N
1-199 = \$.68 200+ = \$.60			
BASE		O.D.	CAT #
1-1/4"	Steel	7/8"	G-45
1-1/4"	Nylon	7/8"	G-45N
1-199 = \$.64 200+ = \$.56			



SWIVEL GLIDE

BASE		O.D.	CAT #
1-1/4"	Steel	1-1/8"	G-47
1-1/4"	Nylon	1-1/8"	G-47N
1-99 = \$.81 100-199 = \$.75 200+ = \$.68			

WWW.CENTARIND.COM
e-mail:
CUSTSERVICE@CENTARIND.COM



Centar Industries INCORPORATED
16313 WESTWOODS BUSINESS PARK, ELLISVILLE, MO 63021
CALL TOLL FREE: 1-800-843-7878 • FAX 1-636-391-2336

IN ST. LOUIS CALL:
636-391-2333

CHAIR GLIDES



AMERICAN SEATING

BASE	O.D.	I.D.	CAT #
1-3/16"	11/16"	9/16"	G-48

1-99 = **\$.66**
100-199 = **\$.60**
200+ = **\$.53**

OLD STYLE NEW



VIRCO AND OTHER 7/8" TUBING

BASE	O.D.	I.D.	CAT #
15/16"	7/8"	3/4"	G-15

1-99 = **\$.68**
100-199 = **\$.65**
200+ = **\$.55**



HEYWOOD WAKEFIELD

BASE	O.D.	I.D.	CAT #
1-1/16"	3/4"	5/8"	G-90
1-1/16"	7/8"	3/4"	G-92

\$.72

For Straight Tube

NYLON GLIDE CAPS



G-120 Angled

BASE SIZE	CAT #	1-999	1000-2999	3000+
1"	G-109	\$.27	\$.26	\$.25
1-1/16"	G-110	\$.18	\$.17	\$.16
1-3/16"	G-115	\$.18	\$.17	\$.16
1-1/4"	G-120 Angled	\$.18	\$.17	\$.16
1-1/4"	G-121	\$.18	\$.17	\$.16
1-3/8"	G-123	\$.27	\$.26	\$.25
1-1/2"	G-125	\$.48	\$.48	\$.48



EUREKA, VIRCO

BASE	O.D.	I.D.	CAT #
1-1/16"	3/4"	5/8"	G-107
1-1/16"	7/8"	3/4"	G-106
1-1/16"	1"	7/8"	G-105

1-999 = **\$.63**
200+ = **\$.60**

NYLON GLIDE CAP WITH FELT PAD



BASE SIZE	CORNER HEIGHT	CAT #
1-1/4"	1/4"	G-118
1-1/4"	5/16"	G-119

1-999 = **\$.32**
1000-2999 = **\$.30**
3000+ = **\$.28**



FOR SQUARE TUBING

BASE	O.D.	I.D.	CAT #
1-1/16"	3/4"	5/8"	G-03
1-1/16"	7/8"	3/4"	G-05
1-1/16"	1"	7/8"	G-10
1-1/16"	1-1/8"	1"	G-25

1-999 = **\$.70**
200+ = **\$.60**

FELT BASE GLIDE



Fits 1/4" Diameter Hole in Tubing and has a 7/8" Base
Cat # G-345

1-999 = **\$.26**
1000-2999 = **\$.25**
3000+ = **\$.24**

#G-127



#G-128

CLEAR SLED BASE CHAIR GLIDES

I.D.	CAT #
7/16" Krueger/Virco	G-127
5/8"	G-128

1-99 = **\$.83**
100-199 = **\$.78**
200+ = **\$.69**

NYLON SLED BASE GLIDE



Fits 1/4" Diameter Hole and has a 3/4" Base
Fits 1" OD Tubing
Cat # G-365

\$.25

WWW.CENTARIND.COM
e-mail:
CUSTSERVICE@CENTARIND.COM

Centar Industries INCORPORATED
16313 WESTWOODS BUSINESS PARK, ELLISVILLE, MO 63021
CALL TOLL FREE: 1-800-843-7878 • FAX 1-636-391-2336

IN ST. LOUIS CALL:
636-391-2333

CHAIR GLIDES



NON SWIVEL WITH NUT			
BASE	THREAD	CAT #	
1-1/16"	8-32x1/2	G-130	
1-199 = \$.45 200+ = \$.42			



NON SWIVEL GLIDE			
BASE	THREAD	STEM LENGTH	CAT #
1-1/16"	1/4-20	1"	G-135
	5/16-18	1"	G-140
1-99 = \$.63 100-199 = \$.55 200+ = \$.48			



SWIVEL GLIDE			
BASE	THREAD	STEM LENGTH	CAT #
1-3/16"	1/4-20	1"	G-145
1-199 = \$.67 200+ = \$.59			



ADJUSTABLE SWIVEL GLIDE			
BASE	O.D.	I.D.	CAT #
1-1/4"	5/8"	N/A"	G-150
For any 5/8" O.D. Tubing			
1-199 = \$1.25 200+ = \$1.18			



SWIVEL LEVELING GLIDE			
BASE	THREAD	STEM LENGTH	CAT #
1-3/4"	3/8-16	1-1/2"	G-155
Heavy duty - for tables, etc.			
1-199 = \$.69 200+ = \$.63			



FELT BASE GLIDE			
BASE	THREAD	STEM LENGTH	CAT #
1"	1/4-20	1"	G-390
Heavy duty - for tables, etc.			
1-199 = \$.82 200+ = \$.72			



NON SWIVEL GLIDE			
BASE	THREAD	STEM LENGTH	CAT #
1-3/4"	1/4-20	1"	G-160
1-3/4"	3/8-16	1-1/2"	G-162
Cat #	1-199	200-499	500+
G160	\$0.73	\$0.63	\$0.56
G162	\$1.35	\$1.30	\$1.30

Base is white nylon



NAIL GLIDE	
BASE	CAT #
7/8"	G-165
7/8"	G-165N
1-9 = \$16.00 per 100 10+ = \$15.00 per 100 Sold in 100's Only.	

For wood furniture



NAIL GLIDE	
BASE	CAT #
1-1/16"	G-170
1-1/16"	G-170N
1-9 = \$23.00 per 100 10+ = \$20.00 per 100 Sold in 100's Only.	

For wood furniture



COUNTERSUNK BASE WITH RIVET	
BASE	CAT #
7/8"	G-175
1-99 = \$.75 100-199 = \$.70 200+ = \$.65	



FELT PAD NAIL GLIDE		
BASE	CAT #	PRICE
7/8"	G-385	\$27.00 per 100
1"	G-386	\$35.00 per 100
1-1/2"	G-387	\$45.00 per 100
Sold in 100's Only.		

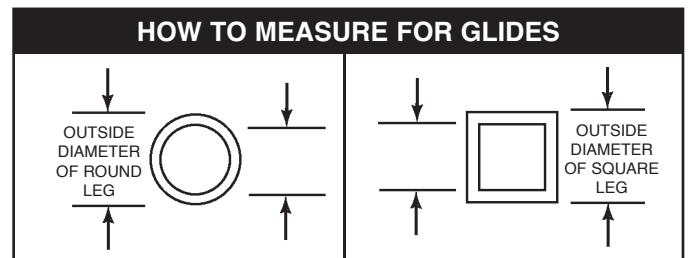

WWW.CENTARIND.COM
e-mail:
CUSTSERVICE@CENTARIND.COM

Centar Industries INCORPORATED
16313 WESTWOODS BUSINESS PARK, ELLISVILLE, MO 63021
CALL TOLL FREE: 1-800-843-7878 • FAX 1-636-391-2336

IN ST. LOUIS CALL:
636-391-2333

CHAIR GLIDES

RUBBER CRUTCH TIP (BLACK)



O.D.	CAT # (Ribbed)	CAT # (Smooth)	Price
5/8"	G-205	G-235	\$.38
3/4"	G-210	G-240	\$.40
7/8"	G-215	G-245	\$.44
1"		G-250 White	\$.70
1"	G-220	G-250 Black	\$.55
1-1/8"	G-225		\$.75
1-1/4"	G-230		\$.67

BRUNSWICK



BLACK RUBBER FOOT WITH METAL CAP

FRONT CHAIR FOOT Cat # G-70

\$.94

BRUNSWICK



BLACK RUBBER FOOT WITH METAL CAP

REAR CHAIR FOOT Cat # G-75

\$.94

PLASTIC CHAIR TIP



O.D.	CAT #	1-99	100-199	200+
5/8"	G-265	\$.30	\$.27	\$.25
3/4"	G-270	\$.30	\$.27	\$.25
7/8"	G-275	\$.30	\$.28	\$.25
1"	G-280	\$.31	\$.28	\$.25
1-1/8"	G-282	\$.50	\$.46	\$.41

BRUNSWICK



BLACK RUBBER FOOT WITH METAL CAP

TABLE LEG Cat # G-80

\$.94

SICO TABLE GLIDES



1" O.D. for Center Frame Black
Cat # G-285
\$2.10

1" O.D. for Top of Leg Black Plastic
Cat # G-290
\$.95

3/8" O.D. for Locking Leg
Cat # G-295
\$1.05

BRUNSWICK



REPLACEMENT METAL CAP

Cat # G-85

\$.70

LYON



BLACK RUBBER STOOL FOOT

BASE 1-13/16" CAT #
HEIGHT 1-1/8" G-300

\$2.25

HOW TO MEASURE FOR GLIDES



CHAIR LEG

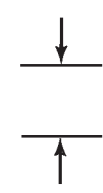

CHAIR LEG

WWW.CENTARIND.COM
e-mail:
CUSTSERVICE@CENTARIND.COM



Centar Industries INCORPORATED
16313 WESTWOODS BUSINESS PARK, ELLISVILLE, MO 63021
CALL TOLL FREE: 1-800-843-7878 • FAX 1-636-391-2336

IN ST. LOUIS CALL:
636-391-2333

CHAIR GLIDES



GRATER CLIPS FOR HEAVY LOADS

O.D.	I.D.	CAT #
7/8"	3/4"	G-180
1"	7/8"	G-185

To be used with 1/4-20 Thread Stem

1-99 = **\$.48**
 100-199 = **\$.45**
 200+ = **\$.44**



LYON

RUBBER FEET FOR FOLDING CHAIRS

A. FRONT	Cat # G-305
B. REAR	Cat # G-310

\$1.50



GRATER CLIPS FOR HEAVY LOADS

O.D.	I.D.	CAT #
1-1/4"	1"	G-190

To be used with 1/4-20 Thread Stem.

1-99 = **\$.95**
 100-199 = **\$.90**
 200+ = **\$.85**



ATTACHMENT HARDWARE FOR LYON FOLDING CHAIRS

HARDWARE SET FOR ALL 4 LEGS
 CAT # G-315

\$7.50



SQUARE INSERTS ROUND BOTTOM

O.D.	CAT #
3/4"	G-335
13/16"	G-336
7/8"	G-337

1-999 = **\$.16**
 1000-2999 = **\$.14**
 3000+ = **\$.13**



STACKING CHAIR BUMPER

STACKING CHAIR BUMPER-GRAY CAT # G-350
 3/4" BASE & 5/16" STEM

1-999 = **\$.15**
 1000-2999 = **\$.13**
 3000+ = **\$.12**



SQUARE INSERTS FLAT BOTTOM

O.D.	CAT #
3/4"	G-338
7/8"	G-339

1-999 = **\$.25**
 1000-2999 = **\$.24**
 3000+ = **\$.23**



CLARIN

RUBBER FEET FOR FOLDING CHAIRS
 CAT # G-320

\$2.25



TUBE CAP

O.D.	CAT #	PRICE
7/8"	G-195	\$14.00 per 100
1"	G-200	\$17.00 per 100

Sold in 100's Only.



A.

AMERICAN SEATING FOLDING CHAIRS-TAN
 CAT # G-325
\$2.20

B.

HOSTESS CHAIRS-BLACK
 CAT # G-330
\$3.50