

TOILET PARTITION PARTS

SURFACE SLIDE LATCHES

#P505*
1-11 = \$6.25
12+ = \$5.95
5/8" Bar to door

#P506*
\$7.70
3/8" Bar to door

#P502**
1-11 = \$5.95
12+ = \$5.60
9/16" Bar to door

#P503**
\$7.15
3/8" Bar to door

#PS90
\$9.00

* To mount the P505 and P506 on 1" doors, use the PC34 screw and PC41 barrel nut.

** To mount the P502 and P503 on 1" doors, use the P9463 screw and P9763 unslotted barrel nut.

#P515
1-6 = \$10.00
7+ = \$9.10

#PC05
\$10.00

#P6309
\$9.50

#P6409
\$14.25

#P6539
\$2.00

#P60491
\$12.50

CONCEALED LATCHES

#P520
\$8.00
(Specify straight or offset bar)

#P138
1-11 = \$5.95
12+ = \$5.75 (set)

#P137HC
\$6.00 (set)

DOOR PULLS

#P540
1-11 = \$3.00
12+ = \$2.75
3-1/2" cc holes

#P620
\$2.15
2-3/4" cc holes

STRIKE AND KEEPER FOR ROUND EDGE PILASTER 1-1/4" THICK

#P551
1-11 = \$4.00
12+ = \$3.75

#P552
1-11 = \$5.00
12+ = \$4.50

P530
\$1.45
Bumper only for strike & keeper

#P533
1-11 = \$6.00
12+ = \$5.40
Inswing

#P531
1-11 = \$6.00
12+ = \$5.40
Inswing

#P541
1-11 = \$6.00
12+ = \$5.40
Outswing

STRIKE AND KEEPER FOR SQUARE EDGE PILASTER 1-1/4" THICK

#P511
1-11 = \$6.00
12+ = \$5.40
Inswing

#P530
1-11 = \$6.00
12+ = \$5.40
Outswing

#P513
\$8.00
Inswing

#P583
\$6.00
Inswing

#P592
\$5.00

#P523
\$7.00

STRIKE AND KEEPER FOR FLAT SURFACES

#P528
\$10.00

#P514
1-6 = \$4.50
7+ = \$4.00

#P524
1-6 = \$4.50
7+ = \$4.00

#P526
1-6 = \$4.50
7+ = \$4.00

STRIKE AND KEEPER FOR ANY TYPE OF THICKNESS PILASTER

#P516
1-6 = \$4.00
7+ = \$3.60

#P517
1-6 = \$4.00
7+ = \$3.60

#P518
1-6 = \$4.00
7+ = \$3.60

1-1/2" Between Screws

WWW.CENTARIND.COM
e-mail:
CUSTSERVICE@CENTARIND.COM

Centar Industries INCORPORATED
16313 WESTWOODS BUSINESS PARK, ELLISVILLE, MO 63021
CALL TOLL FREE: 1-800-843-7878 • FAX 1-636-391-2336

IN ST. LOUIS CALL:
636-391-2333

TOILET PARTITION PARTS

SURFACE MOUNTED GRAVITY HINGE SET

Brass Chrome plated



#P7011 R.H.
1-3 = **\$29.75**
4+ = **\$27.50**

#P7021 L.H.
1-3 = **\$29.75**
4+ = **\$27.50**

Cat. No. P7011 for Right Hand Inswing or Left Hand Outswing
Cat. No. P7021 for Right Hand Outswing or Left Hand Inswing

Stainless steel



#P7031
#P7041
1-3 = **\$32.00**
4+ = **\$29.00**

Cat. No. P7031 (for right hand inswing or left hand outswing.)
Cat. No. P7041 (for right hand outswing or left hand inswing.)

57-1/2" STAINLESS STEEL CONTINUOUS PIANO HINGE

Cat. No. P7649 (w/out self closing or lift feature)
Cat. No. P7659 (Spring loaded, self closing) for RH inswing or LH outswing
Cat. No. P7669 (Spring loaded, self closing) for LH inswing or RH outswing

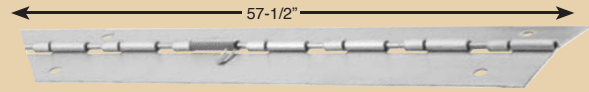

#P7649
\$46.50

#P7659
\$56.50

#P7669
\$56.50

TWO EAR WALL BRACKET

Part No.	Panel Thickness	Bracket Height	Price
P162	.75"	2.5"	\$4.00
P163	.875"	2.5"	\$4.00
P175	1.0"	2.5"	\$3.25
P126	1.0"	3.5"	\$6.00
P183	1.25"	2.5"	\$3.25
P181	1.25"	1.75"	\$4.00
P130	1.25"	3.5"	\$6.00



Call for other sizes
See page 59 for stainless steel brackets
Aluminum brackets available

ONE EAR WALL BRACKET

Part No.	Panel Thickness	Bracket Height	Price
P165	.875"	2.5"	\$4.00
P127	1.0"	3.5"	\$6.00
P176	1.0"	2.5"	\$3.25
P182	1.125"	2.5"	\$8.00
P184	1.25"	2.5"	\$3.25
P131	1.25"	3.5"	\$6.00
P185	1.25"	1.75"	\$4.00



HEADRAIL BRACKETS

Part No.	Panel Thickness	Bracket Height	Price
P215	1.0"	1.0"	\$2.40
P216	1.25"	1.0"	\$2.40



URINAL SCREEN BRACKETS

Part No.	Panel Thickness	Bracket Height	Price
P128	1.0"	3.5"	\$7.00
P133	1.25"	3.5"	\$7.50



Part No.	Panel Thickness	Bracket Height	Price
P270	1.0"	12.0"	\$32.00
P250	1.25"	6.0"	\$12.00

END PLUGS



#P6660
(zamak)
\$1.75

#P6665
(plastic)
\$1.85

1-1/2"x1"



#P667
\$1.70

1-1/2"x1"

U BRACKETS

Part No.	Panel Thickness	Bracket Height	Price
P189	.75"	1.35"	\$2.50
P190	.875"	1.35"	\$2.50
P191	1.0"	1.35"	\$2.50
P194	1.25"	1.35"	\$2.50
P129	1.0"	2.50"	\$5.00
P195	1.25"	2.50"	\$5.20



TWO PIECE BRACKETS

Part No.	Panel Thickness	Bracket Height	Price
P132	ANY	3.5"	\$8.00
P186	ANY	2.5"	\$6.00

ALCOVE CLIP

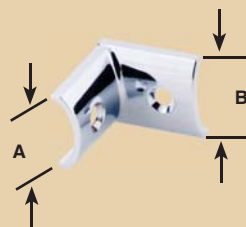

#P834
\$2.10 ea.



4 required per panel,
screws not included

Part No.	A	B	Price
P155 (Metpar)	1-5/32"	1-1/4"	\$2.00
P833 (Flush)	1-1/32"	1-1/4"	\$2.00

WWW.CENTARIND.COM
e-mail:
CUSTSERVICE@CENTARIND.COM



Centar Industries INCORPORATED
16313 WESTWOODS BUSINESS PARK, ELLISVILLE, MO 63021
CALL TOLL FREE: 1-800-843-7878 • FAX 1-636-391-2336

IN ST. LOUIS CALL:
636-391-2333

TOILET PARTITION PARTS

PILASTER SHOE – ROUND Stainless Steel 1-1/4" Pilasters

Part No.	Size	Price
P3899	2"	\$15.00
P3909	3"	\$15.00
P3919	4"	\$15.00
P3929	5"	\$15.00
P3939	6"	\$15.00
P3949	8"	\$16.00
P3959	10"	\$17.00
P3969	12"	\$18.00
P3979	14"	\$20.00



PILASTER SHOE – SQUARE Stainless Steel 1-1/4" Pilasters

Part No.	Size	Price
P3799	2"	\$10.00
P3809	3"	\$10.00
P3819	4"	\$10.00
P3829	5"	\$10.00
P3839	6"	\$10.00
P3849	8"	\$10.00
P3859	10"	\$10.00
P3869	12"	\$12.00
P3879	14"	\$14.00



UNSLOTTED BARREL NUT

Part No.	Length	Price
P9763	1/2" L x 8-32	\$.15



SHEET METAL SCREW

Part No.	Length	Price
P9164	10 x 3/8"	\$.07
P9163	10 x 3/4"	\$.08
P9263	14 x 5/8"	\$.14

Round Head



BARREL NUTS

Part No.	Length	Price
P9713	1/2" L x 10-24	\$.15



TORX HEAD NUT

Part No.	Length	Price
PC41	1/2"	\$.16
PC40	1" SS	\$.30



"QWIK-FIX" KITS



Inswing for 1" doors, Round Edge #P1000 **\$23.75**

Inswing for 1" doors, Square Edge #P1003 **\$23.75**

Outswing for 1" doors, Round Edge #P1001 **\$19.25**

Outswing for 1" doors, Square Edge #P1004 **\$19.25**

(Outswing does not include keeper)

ONE WAY SHOULDER SCREWS

Part No.	Length	Price
P9822	1/2" L	\$.14
P9823	3/4" L	\$.14
P9824	15/16" L	\$.14
P9873	1-5/16" L	\$.14



TORX HEAD SCREW

Part No.	Size	Price
PC32	3/8"	\$.15
PC33	1/2"	\$.16
PC34	3/4"	\$.16
PC35	3/4" SS	\$.30
PC38	1-1/16"	\$.16
PC36	1-3/16"	\$.16
PC37	1-5/16"	\$.16



HOOKS

BUMPER HOOK
Cat. No. P426 Zamak
\$1.50



BUMPER HOOK
Cat. No. P400 Zamak
\$3.00



TWO PRONG HOOK
Cat. No. P402 Zamak
1-99 = **\$1.10**
100+ = **\$1.00**



PILASTER ANCHOR PAK

Cat. No. P31016 All necessary screw and anchors included. Used with stainless pilaster shoe series.

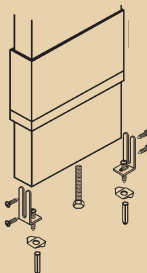

#P31016 **\$14.00**

ONE WAY MACHINE SCREWS

Part No.	Length	Price
P9403	5/8" L x 8-32	\$.08
P9413	3/4" L x 8-32	\$.08
P9423	1" L x 8-32	\$.08
P9443	1-1/8" L x 8-32	\$.08
P9463	1-3/8" L x 8-32	\$.08
P9483	1-5/8" L x 8-32	\$.08



UN-DO-IT FOR REMOVING ONE WAY SCREWS

Part No.	Size	Price
P100807	6 & 8	\$14.65
P100810	8 & 10	\$14.85
P100814	12 & 14	\$15.70



TORX BIT

#PC45 **\$4.00**



DOOR STOP

Cat. No. P412 Zamak **\$2.00**



FLOOR SHOE

Cat. No. P304 for 1-3/4" x 1-3/4" Post Zamak **\$7.00**



WWW.CENTARIND.COM
e-mail:
CUSTSERVICE@CENTARIND.COM



Centar Industries INCORPORATED
16313 WESTWOODS BUSINESS PARK, ELLISVILLE, MO 63021
CALL TOLL FREE: 1-800-843-7878 • FAX 1-636-391-2336

IN ST. LOUIS CALL:
636-391-2333

STAINLESS STEEL HARDWARE

CAST STAINLESS STEEL HARDWARE

Slide Latch

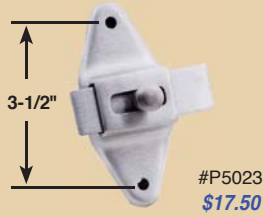

One Ear Wall Bracket



Cat. No. P1763 – 1" thick
Cat. No. P1843 – 1-1/4" thick
\$11.00

Two Ear Wall Bracket



Cat. No. P1753 – 1" thick
Cat. No. P1833 – 1-1/4" thick
#P1753 – \$12.00
#P1833 – \$15.00

Door Pull

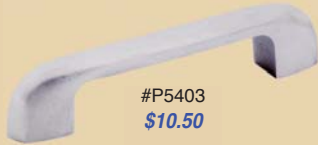

Inswing Strike and Keeper



Outswing Strike and Keeper



STAMPED STAINLESS STEEL HARDWARE

Slide Latch



use with #P6309

Inswing Latch and Keepers Combo Strike



use with #P6409



Hinge Set



Strike and Keeper – specify door thickness



Cat. No. P7031 (for right hand inswing or left hand outswing.)
Cat. No. P7041 (for right hand outswing or left hand inswing.)

SS DOUBLE WALL BRACKETS

One Ear Wall Bracket

Cat. No. P1769 – 1" thick
Cat. No. P1849 – 1-1/4" thick



Cat. No. P2279 – 1" thick
Cat. No. P2299 – 1-1/4" thick



Two Ear Wall Bracket

Cat. No. P1759 – 1" thick
Cat. No. P1839 – 1-1/4" thick



Cat. No. P2269 – 1" thick
Cat. No. P2289 – 1-1/4" thick



U Bracket

Cat. No. P2329 – 1" thick
Cat. No. P2999 – 1-1/4" thick



WWW.CENTARIND.COM
e-mail:
CUSTSERVICE@CENTARIND.COM



Centar Industries INCORPORATED
16313 WESTWOODS BUSINESS PARK, ELLISVILLE, MO 63021
CALL TOLL FREE: 1-800-843-7878 • FAX 1-636-391-2336

IN ST. LOUIS CALL:
636-391-2333

TOILET PARTITION ACCESSORIES

TOILET PAPER DISPENSERS

SINGLE ROLL 9" JUMBO ROLL

- Front color: Dark translucent or white
- Stainless Steel available (call for pricing)

#P26TS
\$17.50

DOUBLE ROLL 9" JUMBO ROLL

#P27TS
\$30.25



KEYED 2 ROLL TYPE

- Front color: Dark translucent or white
- Stainless Steel available (call for pricing)

#P25TS
\$21.25



CONTROLLED DELIVERY DOUBLE ROLL HOLDER

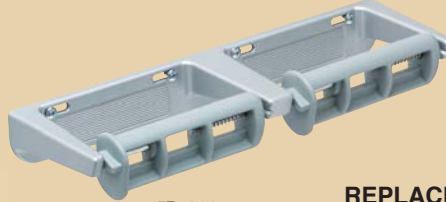

#P7389
\$16.25

CONTROLLED DELIVERY SINGLE ROLL HOLDER



#P7399
\$8.75

REPLACEMENT DISPENSER SPINDLE



#P7379
\$5.25

SINGLE ROLL PAPER HOLDER



#P7359
1-6 = \$6.00
7+ = \$5.40

DOUBLE ROLL PAPER HOLDER



#P7369
1-6 = \$10.00
7+ = \$ 9.00

SOAP DISPENSERS

STAINLESS STEEL HORIZONTAL SOAP DISPENSER

- 8" w x 5" h x 3" d
- Capacity – 40 oz



#P7419
\$29.75

STAINLESS STEEL VERTICAL SOAP DISPENSER

- 5" w x 8" h x 3" d
- Capacity – 40 oz



#P7430
PUMP ONLY
\$21.00



#P7429
LENS ONLY
(5 pack)
\$8.25

#P7409
\$34.25

SANI SUDES SOAP & SANITIZER DISPENSER

#SF305
\$39.50

- Touchless system helps reduce contamination



NON-ALCOHOL FOAM SANITIZER

3 Refills = 9,000 Washes

#SF7500
\$63.60

ANTIBACTERIAL FOAM SOAP

3 Refills = 9,000 Washes

#SF7125
\$63.60

PUSH UP SOAP DISPENSER

- 4" w x 6" h x 5" d
- Capacity – 16 oz

#P7449
\$9.25



PLASTIC LIQUID OR LOTION SOAP DISPENSER

- 5" w x 6" h x 4" d
- Capacity – 46 oz

#P46TS
\$23.25



TOWEL DISPENSERS

C-FOLD, MULTI-FOLD PAPER TOWEL DISPENSER

- 11" w x 15" h x 4" d
- Heavy Gauge Steel Back
- Front: White or Dark Translucent
- Holds 540 Multi-fold or 335 C-fold Towels



#P175TS
\$23.75

ROLL TYPE – SELF ADJUSTING CENTER PULL DISPENSER

- 10" w x 12" h x 10" d
- Cover color: Dark Translucent
- Holds rolls up to 9" dia x 9" tall



#P255TS
\$28.00

ROLL TYPE – BOTTOM PULL PAPER TOWEL DISPENSER

- 11" w x 16" h x 9" d
- Heavy Gauge Steel Back with Translucent Front
- For rolls 8" w x 8" dia



#P400TS
\$79.00

C-FOLD, MULTI-FOLD METAL PAPER TOWEL DISPENSER

- 11" w x 8" h x 4" d
- Holds 275 Multi-fold or 200 C-fold

C-FOLD, MULTI-FOLD METAL PAPER TOWEL DISPENSER

- 11" w x 15" h x 4" d
- Holds 525 Multi-fold or 400 C-fold



#P7539
\$43.10



#P7549
\$47.25

WWW.CENTARIND.COM
e-mail:
CUSTSERVICE@CENTARIND.COM



Centar Industries INCORPORATED
16313 WESTWOODS BUSINESS PARK, ELLISVILLE, MO 63021
CALL TOLL FREE: 1-800-843-7878 • FAX 1-636-391-2336

IN ST. LOUIS CALL:
636-391-2333

MISCELLANEOUS TOILET PARTITION PARTS

54" CONTINUOUS PLASTIC BRACKET FOR 1" MATERIAL

		"A" PANEL SIZE	"B" BRACKET HEIGHT	"C" BRACKET WIDTH
P222	Two Ear Bracket	1"	2-3/4"	3-3/4"
P227	One Ear Bracket	1"	2-3/4"	2-5/8"

57-1/2" CONTINUOUS ALUMINUM WALL BRACKETS

Also available in 54" length.

		"A" PANEL SIZE	"B" BRACKET HEIGHT	"C" BRACKET WIDTH
P220	Two Ear Bracket	1"	2-3/4"	3-3/4"
P225	One Ear Bracket	1"	2-3/4"	2-5/8"
P230	One Ear Bracket	1-1/4"	2-3/4"	2-5/8"
P235	"U" Bracket	1"	1-3/8"	1-11/32"

57" CONTINUOUS STAINLESS STEEL WALL BRACKET

		"A" PANEL SIZE	"B" BRACKET HEIGHT	"C" BRACKET WIDTH
P2349	Two Ear Bracket	1"	2-1/2"	3-11/16"
P2339	One Ear Bracket	1"	2-1/2"	2-13/32"
P2359	One Ear Bracket	1-1/4"	2-1/2"	2-11/16"
P2369	"U" Bracket	1"	1-1/2"	1-3/16"

41" CONTINUOUS ALUMINUM URINAL SCREEN WALL BRACKET

		"A" PANEL SIZE	"B" BRACKET HEIGHT	"C" BRACKET WIDTH
P240	Two Ear Bracket	1"	2"	3-1/8"

ALUMINUM
#P220 - ~~\$39.50~~
#P240 - ~~\$27.00~~

STAINLESS
#P2349 - ~~\$67.00~~

PLASTIC
#P222 - ~~\$19.50~~

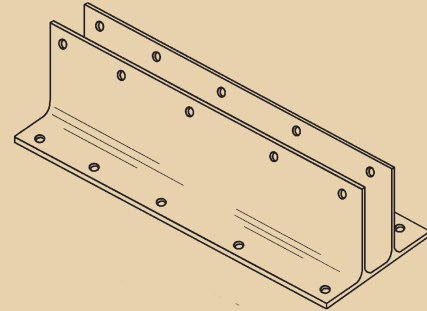

ALUMINUM
#P225 - ~~\$39.50~~
#P230 - ~~\$39.50~~

STAINLESS
#P2339 - ~~\$57.00~~
#P2359 - ~~\$59.00~~

PLASTIC
#P227 - ~~\$19.50~~

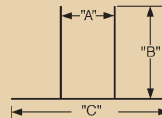
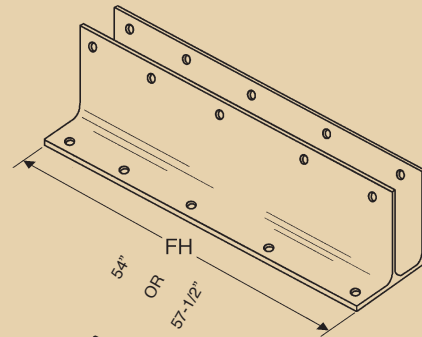

ALUMINUM
#P235
~~\$30.00~~

STAINLESS
#P2369
~~\$50.00~~

RESTROOM SIGNS

- ADA Compliant
- 6" x 9" Braille Signs
- Vandal Resistant
- Self Adhesive Backing
- Indoor or Outdoor Use
- Color: Blue with white lettering



#P200M
~~\$11.85~~



#P201MH
~~\$11.85~~



#P202W
~~\$11.85~~



#P203WH
~~\$11.85~~

WWW.CENTARIND.COM
e-mail:
CUSTSERVICE@CENTARIND.COM



Centar Industries INCORPORATED
16313 WESTWOODS BUSINESS PARK, ELLISVILLE, MO 63021
CALL TOLL FREE: 1-800-843-7878 • FAX 1-636-391-2336

IN ST. LOUIS CALL:
636-391-2333

ACCURATE

TOP HINGE



Cat. #PA05
\$10.00

BOTTOM HINGE



Cat. #PA10
\$10.00

TOP CAM



Cat. #PA15
\$5.00

BOTTOM CAM



Cat. #PA20
\$7.75

LATCH PIN



Cat. #PA25
\$4.00



INSERT CAP
Cat. #PA45
\$5.00

HANDICAP KNOB



Cat. #PA37
\$18.00

LATCH KNOB



Cat. #PA30
\$7.00

LATCH COVER



Cat. #PA35
\$7.00

HINGE PIN



Cat. #PA40
\$3.00

NYLON CAM (Laminate)



Cat. #PA60
\$2.50

PINTLE (Laminate)



Cat. #PA65
\$2.50

STRIKE & KEEPER



Cat. #PA50
\$7.50

SLIDE LATCH

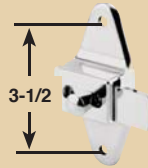

Cat. #P505
1-11 = **\$6.25**
12+ = **\$5.95**

TOP HINGE



Cat. #PA55
\$12.00

BOTTOM HINGE



Cat. #PA57
\$12.00

SLIDE LATCH

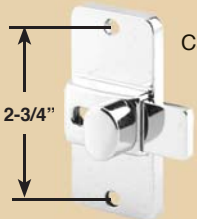

Cat. #PA52
\$13.25

1" INSWING STRIKE & KEEPER



Cat. #PA54
\$8.00

3/4" and 1-1/4" available

HINGE PIN



Cat. #PA105
\$3.50

STRIKE & KEEPER



Cat. #P521
1-11 = **\$6.00**
12+ = **\$5.40**

STRIKE & KEEPER



Cat. #P511
1-11 = **\$6.00**
12+ = **\$5.40**

AMERICAN SANITARY

BOTTOM HINGE



Cat. #PA75
\$10.00

TOP HINGE



Cat. #PA80
\$10.00

SLIDE LATCH

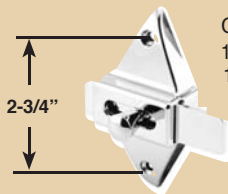

Cat. #P502
1-11 = **\$5.95**
12+ = **\$5.60**

CAM (Baked Enamel)



Cat. #PA85
\$3.00

PINTLE



Cat. #P310
\$3.00

STRIKE & KEEPER



Cat. #P511
1-11 = **\$6.00**
12+ = **\$5.40**

STRIKE & KEEPER



Cat. #P521
1-11 = **\$6.00**
12+ = **\$5.40**

CAM (Laminate)



Cat. #PA95
\$3.00

PIN (Metal)



Cat. #PA90
\$3.00

PIN (Laminate)



Cat. #PA105
\$3.50

WWW.CENTARIND.COM
e-mail:
CUSTSERVICE@CENTARIND.COM



Centar Industries INCORPORATED
16313 WESTWOODS BUSINESS PARK, ELLISVILLE, MO 63021
CALL TOLL FREE: 1-800-843-7878 • FAX 1-636-391-2336

IN ST. LOUIS CALL:
636-391-2333

ALL AMERICAN

METAL PARTITIONS

BOTTOM HINGE



TOP HINGE



BRACKET



PINTLE



TOP PIN
(Baked Enamel)

Cat. #PAA20
\$2.50

SHOE CLIP



CAM HOUSING



MALE & FEMALE KNOB (Set)



HANDICAP MALE & FEMALE KNOB (Set)



STRIKE & KEEPER



NYLON CAM

Cat. #PAA30
\$3.00

LAMINATE PARTITIONS

NYLON CAM



BOTTOM HINGE



TOP HINGE



TOP PIN
(Laminate)

Cat. #PAA45
\$3.50

STRIKE & KEEPER

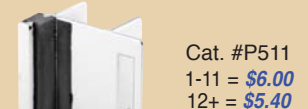

TOP HINGE DOOR INSERT



BOTTOM HINGE DOOR INSERT

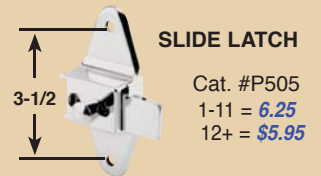

SCRANTON / COMTEC

SLIDE LATCH



8" TOP & BOTTOM HINGES



TOP HINGE DOOR INSERT



BOTTOM HINGE DOOR INSERT



INTEGRAL HINGE SET



3/4" TORX HEAD SCREW



1" TORX HEAD BARREL NUT

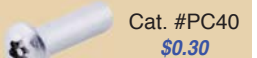

TORX BIT



DOOR STOP



6" STRIKE & KEEPER

Cat. #PC15
\$12.00

6" STRIKE & KEEPER

Cat. #PC20
\$12.00

WWW.CENTARIND.COM
e-mail:
CUSTSERVICE@CENTARIND.COM



Centar Industries INCORPORATED
16313 WESTWOODS BUSINESS PARK, ELLISVILLE, MO 63021
CALL TOLL FREE: 1-800-843-7878 • FAX 1-636-391-2336

IN ST. LOUIS CALL:
636-391-2333

FLUSH METAL

METAL PARTITIONS

BOTTOM HINGE



Cat. #PF05
\$10.00

TOP HINGE



Cat. #PF10
\$10.00



NYLON CAM
Cat. #PM50
\$2.50



PINTLE
Cat. #P310
\$3.00



TOP PIN
Cat. #PM37 Metal
\$3.00

TOP DOOR INSERT



Cat. #PF50
\$12.00

BOTTOM CAM HOUSING

Cat. #PG110
\$8.00 ea.



STRIKE & KEEPER
Cat. #P551
1-11 = \$4.00
12+ = \$3.75



MALE & FEMALE KNOB (Set)
Cat. #P138 (Set)
1-11 = \$5.95
12+ = \$5.75

LAMINATE PARTITIONS

SLIDE LATCH

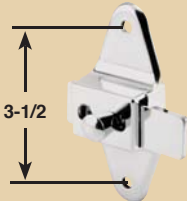

Cat. #P505
1-11 = \$6.25
12+ = \$5.95

BOTTOM HINGE



Cat. #PF35
\$10.00

TOP HINGE



Cat. #PA80
10.00

NYLON CAM



Cat. #PF30
\$2.50

PINTLE



Cat. #P315
\$3.00

TOP PIN



Cat. #PA105
\$3.00

GLOBAL

BOTTOM HINGE



Cat. #PF05
\$10.00

TOP HINGE



Cat. #PF10
\$10.00



MALE & FEMALE KNOB (Set)
Cat. #P138 (Set)
1-11 = \$5.95
12+ = \$5.75



Cat. #P551
1-11 = \$4.00
12+ = \$3.75

STRIKE & KEEPER



Cat. #P531
1-11 = \$6.00
12+ = \$5.40

STRIKE & KEEPER



Cat. #P541
1-11 = \$6.00
12+ = \$5.40



NYLON CAM
Cat. #PM50
\$2.50

BOTTOM CAM HOUSING



Cat. #PG110
\$8.00

SLIDE LATCH

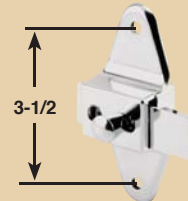

Cat. #P505
1-11 = \$6.25
12+ = \$5.95

PIN



Cat. #PM37
Metal
\$3.00

PIN



Cat. #PG115
\$3.00

WWW.CENTARIND.COM
e-mail
CUSTSERVICE@CENTARIND.COM



















Centar Industries INCORPORATED
16313 WESTWOODS BUSINESS PARK, ELLISVILLE, MO 63021
CALL TOLL FREE: 1-800-843-7878 • FAX 1-636-391-2336

IN ST. LOUIS CALL:
636-391-2333

GENERAL

METAL PARTITIONS

BOTTOM HINGE Cat. #PF05 \$10.00 	TOP HINGE Cat. #PF10 \$10.00 	BOTTOM HINGE Cat. #PG10 \$13.00 	TOP HINGE Cat. #PK05 \$13.00 	TOP HINGE PIN Cat. #PG30 \$3.00 	INTEGRAL HINGE SET  Top Assembly Bottom Assembly Cat. #PG42 \$24.50
TOP PIN Cat. #PK40 \$3.00 	LATCH COVER Cat. #PK25 \$4.00 	LATCH KNOB Cat. #PK20 \$4.00 	ADA LATCH Cat. #PK27 \$10.00 	PINTLE Cat. #P310 \$3.00 	POWER CAM Cat. #PG33 \$7.50 
STRIKE & KEEPER Cat. #P551 1-11 = \$4.00 12+ = \$3.75 	NYLON CAM Cat. #PM50 \$2.50 	BOTTOM CAM HOUSING UNPLATED Cat. #PG20 \$8.00 	TOP HINGE DOOR INSERT Cat. #PG25 \$4.00 	BOTTOM HINGE DOOR INSERT Cat. #PG27 \$6.00 	

LAMINATE PARTITIONS

BOTTOM HINGE Cat. #PG35 \$10.00 	TOP HINGE Cat. #PA80 \$10.00 	NYLON CAM Cat. #PA95 \$3.00 	CONCEALED LATCH Cat. #P520 \$8.00 Specify straight or offset bar. 	STRIKE & KEEPER Cat. #P592 \$5.00 	TOP PIN Cat. #PA105 \$3.00 
--	---	--	--	--	--

HADRIAN

BOTTOM HINGE Cat. #PH05 \$15.00 	TOP HINGE Cat. #PH10 \$15.00 	BOTTOM HINGE Cat. #PH30 \$12.00 	TOP HINGE Cat. #PH35 \$12.00 	PINTLE Cat. #PH40 \$4.00 	STRIKE & KEEPER 1-1/4" Cat. #P551 1-11 = \$4.00 12+ = \$3.75 
MALE & FEMALE KNOB (Set) Cat. #PH20 (Set) \$13.00 	MALE & FEMALE HC Cat. #PH25HC (Set) \$13.75 	TOGGLE & SCREW Cat. #PH45 \$2.50 	STRIKE & KEEPER Cat. #P524 1-6 = \$4.50 7+ = \$4.00 	NYLON CAM Cat. #PH50 \$3.50 	TOP PIN Cat. #PH55 \$2.50 (must replace top hinge) 
					TOP PIN (new style) Cat. #PH60 \$2.50 

WWW.CENTARIND.COM
e-mail:
CUSTSERVICE@CENTARIND.COM

Centar Industries INCORPORATED
16313 WESTWOODS BUSINESS PARK, ELLISVILLE, MO 63021
CALL TOLL FREE: 1-800-843-7878 • FAX 1-636-391-2336

IN ST. LOUIS CALL:
636-391-2333

KNICKERBOCKER

TOP HINGE



Cat. #PK05
\$13.00

BOTTOM HINGE



Cat. #PK10
\$13.00

STRIKE & KEEPER

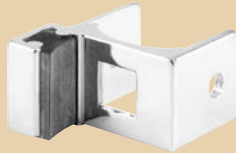

Cat. #PK15
\$8.50

STEEL HINGE PIN



Cat. #PK40
\$3.00

CAM ASSEMBLY



Cat. #PK35
\$8.50

TOP HINGE (LAMINATE)



Cat. #PK07
\$13.00

BOTTOM HINGE (LAMINATE)



Cat. #PK12
\$13.00

LAMINATE CAM ASSEMBLY

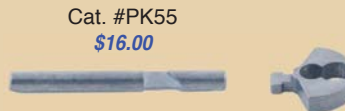

Cat. #PK55
\$16.00

LATCH KNOB



Cat. #PK20
\$4.00

LATCH COVER



Cat. #PK25
\$4.00

ADA LATCH KNOB



Cat. #PK27
\$10.00

BOTTOM CAM HOUSING



Cat. #PG20
\$8.00

PINTLE



Cat. #PK30
\$3.75

METPAR

METAL PARTITIONS

STRIKE & KEEPER



Cat. #P552
1-11 = \$5.00
12+ = \$4.50

SLIDE LATCH



Cat. #PM35
\$8.00

LATCH ASSEMBLY



Cat. #PM40
\$8.50

STRIKE & KEEPER



Cat. #PM32
\$21.00

MILLS SLIDE LATCH



Cat. #PM30
\$20.00

HINGE PIN



Cat. #PM37
Metal
\$3.00

CAM HOUSING UPDATED



Cat. #PM45
\$10.00

TOP HINGE



Cat. #PM60
\$12.00

BOTTOM HINGE



Cat. #PM55
\$12.00

CAM ASSEMBLY



Cat. #PM53
\$7.50

CAM



Cat. #PM50
\$2.50

PINTLE



Cat. #P310
\$3.00

LAMINATE PARTITIONS

BOTTOM HINGE



Cat. #PM65
\$10.00

TOP HINGE



Cat. #PM70
\$10.00

NYLON CAM



Cat. #PA95
\$3.00

PINTLE



Cat. #P315
\$3.00

WWW.CENTARIND.COM
e-mail:
CUSTSERVICE@CENTARIND.COM



Centar Industries INCORPORATED
16313 WESTWOODS BUSINESS PARK, ELLISVILLE, MO 63021
CALL TOLL FREE: 1-800-843-7878 • FAX 1-636-391-2336

IN ST. LOUIS CALL:
636-391-2333

MILLS

TOP HINGE W/PIN



Cat. #PM05
\$18.00

BOTTOM HINGE ASSEMBLY



Cat. #PM10
\$18.00

NYLON CAM AND BOTTOM CAM HOUSING



Cat. #PM27
\$9.00

Nylon Cam and Bottom Cam Housing must be purchased as a set.

SLIDE LATCH ASSEMBLY



Cat. #PM25
\$16.00

SLIDE BOLT LATCH WRENCH

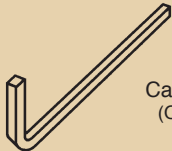

Cat. #PM15
(Old Style)
\$3.00

NOT SURE ???
SEND US A SAMPLE

STRIKE & KEEPER



Cat. #PM20
\$6.00

STRIKE & KEEPER



Cat. #P511
1-11 = \$6.00
12+ = \$5.40

STRIKE & KEEPER



Cat. #P514
1-6 = \$4.50
7+ = \$4.00

SLIDE LATCH & STRIKE & KEEPER SET

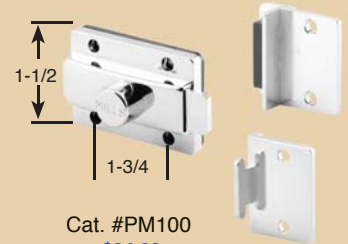

Cat. #PM100
\$34.00
zamak

Cat. #PM115
\$45.00
Stainless Steel

WEIS-ROBART

SLIDE LATCH BOLT

Cat. #PW10
\$10.50

SLIDE COVER PLATE

Cat. #PW20
\$6.50

BOTTOM CAM HOUSING

Cat. #PW25
\$19.00

SLIDE LATCH

Cat. #PW05
\$25.50

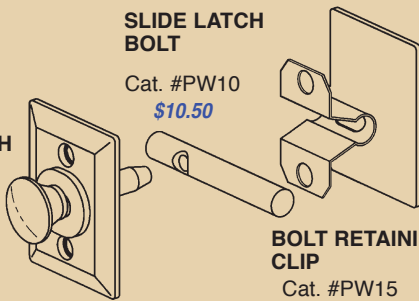

BOLT RETAINING CLIP

Cat. #PW15
\$8.00

NYLON CAM

Cat. #PW30
\$10.00

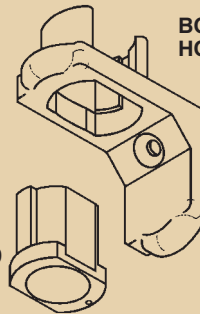

STEEL HINGE PIN

Cat. #PW40
\$9.50

TOP HINGE WITH COVER

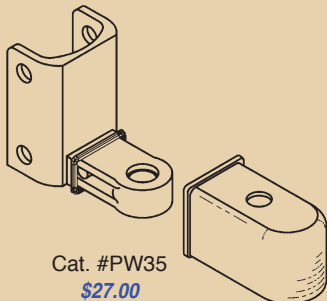

Cat. #PW35
\$27.00

STRIKE & KEEPER



Cat. #PW45
\$25.00



Cat. #PW50

HINGE SET for right hand inswing or left hand outswing

Cat. #P7011 R.H.
1-3 = \$29.75
4+ = \$27.50

HINGE SET for right hand outswing or left hand inswing

Cat. #P7021 L.H.
1-3 = \$29.75
4+ = \$27.50

LIMITED QUANTITIES AVAILABLE

WWW.CENTARIND.COM
e-mail:
CUSTSERVICE@CENTARIND.COM



Centar Industries INCORPORATED
16313 WESTWOODS BUSINESS PARK, ELLISVILLE, MO 63021
CALL TOLL FREE: 1-800-843-7878 • FAX 1-636-391-2336

IN ST. LOUIS CALL:
636-391-2333

SANYMETAL

TOP HINGE



Cat. #PS05
\$13.00

BOTTOM HINGE



Cat. #PS10
\$13.00

TOGGLE & SCREW



Cat. #PH45
\$2.50



Cat. #PS20
\$1.50

DISCONTINUED

TOP HINGE



Cat. #PS25
\$15.00

BOTTOM HINGE



Cat. #PS30
\$15.00

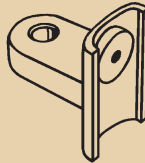

Cat. #PS35
(Use #PS05)
DISCONTINUED

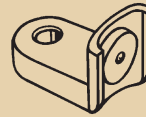

Cat. #PS40
(Use #PS10)
DISCONTINUED

TOP HINGE PIN



Cat. #PS65
\$2.25

HINGE SPRING ASSEMBLY



Cat. #PS60
\$20.00

LATCH COVER



Cat. #PS45
Old Style
\$6.25

LATCH KNOB



Cat. #PS50
Old Style
\$6.25

STRIKE & KEEPER



Cat. #P551
1-11 = \$4.20
12+ = \$4.00

LATCH KNOB & COVER (Set) (pin included)



Cat. #PS47 (set)
New Style (pin included)
\$12.50

BOTTOM HINGE LAMINATE



Cat. #PS105
\$13.25

TOP HINGE LAMINATE



Cat. #PS100
\$13.25

STRIKE



Cat. #PS70
\$18.00

KEEPER



Cat. #PS75
\$9.00

STRIKE & KEEPER LAMINATE



Cat. #P592
\$5.00

HINGE SPRING ASSEMBLY LAMINATE



Cat. #PS85
\$20.00

SLIDE LATCH

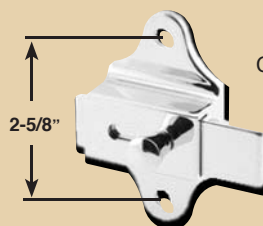

Cat. #PS90
\$9.00

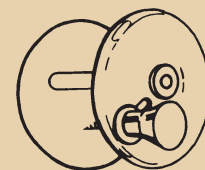

Cat. #PS95

DISCONTINUED

WWW.CENTARIND.COM
e-mail:
CUSTSERVICE@CENTARIND.COM



Centar Industries INCORPORATED
16313 WESTWOODS BUSINESS PARK, ELLISVILLE, MO 63021
CALL TOLL FREE: 1-800-843-7878 • FAX 1-636-391-2336

IN ST. LOUIS CALL:
636-391-2333